

OUTLINE SUSPENDED FIXED 74901

PROJECT PROJÉT
SPEC TYPE
NOTES



FINISH FINI



BLKE

WHE

FAMILY FAMILLE



RECESSED (12900)

SURFACE (46900)

SUSPENDED AIMABLE (74900)

MOUNTING OPTION OPTION DE MONTAGE

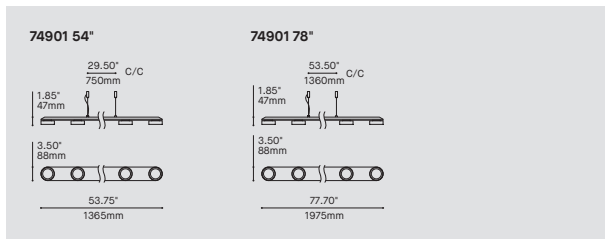
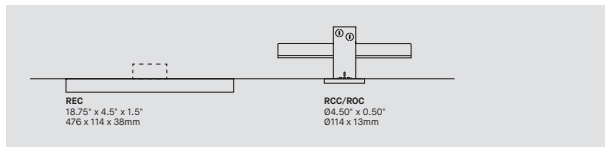

ORDERING SPECIFICATION	SPÉCIFICATION DE COMMANDE	CODE
MODEL MODÈLE		74901
74901	OUTLINE SUSPENDED FIXED	
LIGHT SOURCE DIRECTION	DIRECTION DE LA SOURCE LUMINEUSE	
D	DIRECT	
DI*	DIRECT & INDIRECT (DUAL DIMMING)	
	* DOWNLIGHT AND UPLIGHT ARE DIMMED INDEPENDENTLY	
LUMINAIRE LENGTH	LONGUEUR DU LUMINAIRE	
54	54"	
78	78"	
PROJECTOR CONFIGURATIONS	CONFIGURATIONS DE PROJECTEURS	
	54"	
4X1	4 INDIVIDUAL PROJECTORS	
6X1	6 INDIVIDUAL PROJECTORS	
2X2	2 CLUSTERS OF 2 PROJECTORS – TOTAL OF 4	
3X2	3 CLUSTERS OF 2 PROJECTORS – TOTAL OF 6	
2X3	2 CLUSTERS OF 3 PROJECTORS – TOTAL OF 6	
	78"	
6X1	6 INDIVIDUAL PROJECTORS	
9X1	9 INDIVIDUAL PROJECTORS	
3X2	3 CLUSTERS OF 2 PROJECTORS – TOTAL OF 6	
4X2	4 CLUSTERS OF 2 PROJECTORS – TOTAL OF 8	
2X3	2 CLUSTERS OF 3 PROJECTORS – TOTAL OF 6	
3X3	3 CLUSTERS OF 3 PROJECTORS – TOTAL OF 9	
PROJECTOR LIGHT SOURCE	SOURCE LUMINEUSE PROJECTEURS	
LED.LO	LOW OUTPUT	
LED	REGULAR OUTPUT	
INDIRECT LIGHT SOURCE	SOURCE LUMINEUSE INDIRECTE	
LED.LO	LOW OUTPUT	
LED	REGULAR OUTPUT	
LED.HO	HIGH OUTPUT	
COLOR TEMPERATURE	TEMPÉRATURE DE COULEUR	
27*	2700K	
30	3000K	
35	3500K	
40	4000K	
	* LONGER LEAD TIME MAY APPLY, PLEASE CONTACT YOUR EUREKA REPRESENTATIVE	
COLOR RENDERING INDEX (CRI)	INDICE DE RENDU DE COULEUR (IRC)	
80	80+ CRI	
90*	90+ CRI	
	* LONGER LEAD TIME MAY APPLY, PLEASE CONTACT YOUR EUREKA REPRESENTATIVE	
VOLTAGE	VOLTAGE	
120V	120 VOLT	
277V	277 VOLT	
DIMMING OPTION	OPTION DE GRADATION	DV
DV	0-10V DIMMING (120V-277V)	
EMERGENCY BATTERY	BATTERIE D'URGENCE	
	INSTALLED REMOTELY. SEE EM GUIDE FOR DETAILS.	
EMB*	EMERGENCY BATTERY FOR REMOTE BOX	
	* 3981EA ACCESSORY IS REQUIRED	
BEAM ANGLE	ANGLE DE FAISCEAU	ME
ME	MEDIUM (30°)	
CABLE	CÂBLE	C
C*	BLACK OR WHITE CABLE, FIELD ADJUSTABLE	
	* CABLE FINISH IS COLOR MATCHING BODY FINISH	
CABLE LENGTH	LONGUEUR DE CÂBLE	
60	60" CABLE (STD LENGTH)	
**	CUSTOM CABLE LENGTH (PLEASE SPECIFY)	
	FOR OVERALL LENGTH, PLEASE CONTACT YOUR EUREKA REPRESENTATIVE	
MOUNTING	MONTAGE	
REC	RECTANGULAR CANOPY / PAVILLON RECTANGULAIRE	
RCC*	ROUND CENTERED CANOPY ON J-BOX FOR RECESSED DRIVER(S)	
ROC*	ROUND OFFSET CANOPY ON J-BOX FOR RECESSED DRIVER(S)	
	* 3981F ACCESSORY IS REQUIRED	
CANOPY FINISH	FINI PAVILLON ^(A)	
BLKE	BLACK FINE TEXTURE	
WHE	WHITE FINE TEXTURE	
	^(A) CEILING GRIPPER BLOCS FINISH ARE COLOR MATCHING CANOPY FINISH	
HOUSING & PROJECTOR	BOITIER & PROJECTEUR ^(B)	
BLKE	BLACK FINE TEXTURE	
WHE	WHITE FINE TEXTURE	
	^(B) PROJECTOR FINISH ARE COLOR MATCHING STRUCTURE FINISH	
ACCESSORY	ACCESSOIRE	
3981F	JUNCTION BOX FOR RECESSED DRIVER OPTION (RCC AND ROC)	
EMERGENCY BATTERY ACCESSORY	ACCESSOIRE BATTERIE D'URGENCE	
3981EA	ELECTRICAL BOX FOR EMB EMERGENCY BATTERY	

OUTLINE SUSPENDED FIXED 74901

CONFIGURATIONS

4X1 54"
4 INDIVIDUAL PROJECTORS



6X1 54"
6 INDIVIDUAL PROJECTORS



2X2 54"
2 CLUSTERS OF 2 PROJECTORS – TOTAL OF 4

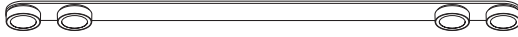

3X2 54"
3 CLUSTERS OF 2 PROJECTORS – TOTAL OF 6



2X3 54"
2 CLUSTERS OF 3 PROJECTORS – TOTAL OF 6



6X1 78"
6 INDIVIDUAL PROJECTORS

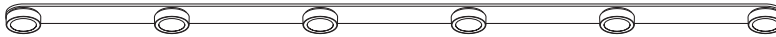

9X1 78"
9 INDIVIDUAL PROJECTORS



3X2 78"
3 CLUSTERS OF 2 PROJECTORS – TOTAL OF 6



4X2 78"
4 CLUSTERS OF 2 PROJECTORS – TOTAL OF 8



2X3 78"
2 CLUSTERS OF 3 PROJECTORS – TOTAL OF 6

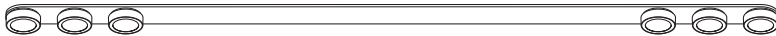

3X3 78"
3 CLUSTERS OF 3 PROJECTORS – TOTAL OF 9

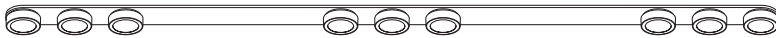

OUTLINE SUSPENDED FIXED 74901

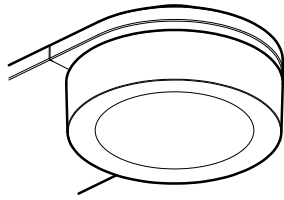

FIXED PROJECTORS
Projectors are fixed for downlight applications. Heads are evenly distributed along luminaire or clustered together.

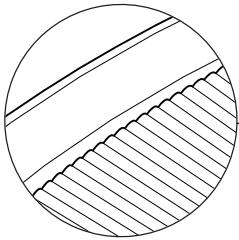

A UNIQUE PATENTED LENS
The innovative lens offers a uniform light beam with great glare control and optical efficiency.

RECTANGULAR CANOPY (REC)
This surface canopy (REC) is installed on a regular 4" JBOX. No visible hardware.

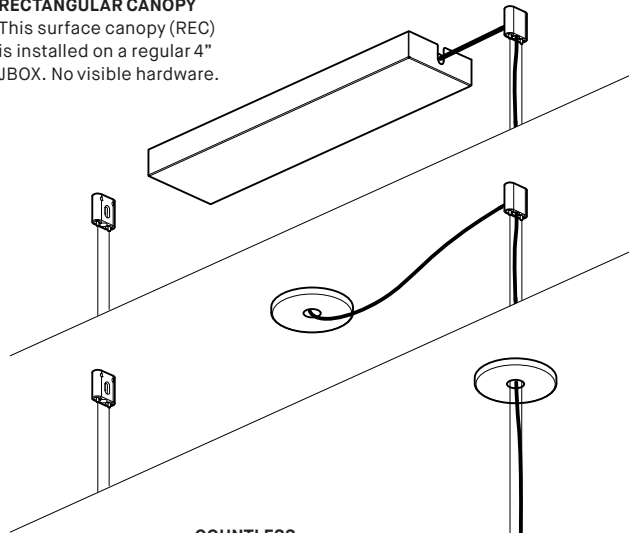

A PATENTED EFFICIENT AND MINIMALIST DESIGN

ROUND CANOPY
This discreet canopy coupled with a special JBOX (3981F, sold separately) hide the driver(s) inside the ceiling. Offered either centered with luminaire (RCC) or offset (ROC). No visible hardware.

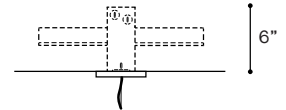

COUNTLESS POSSIBILITIES
Outline's suspended version is offered in two lengths, with a variety of projector configurations to adapt to any space and its needs.

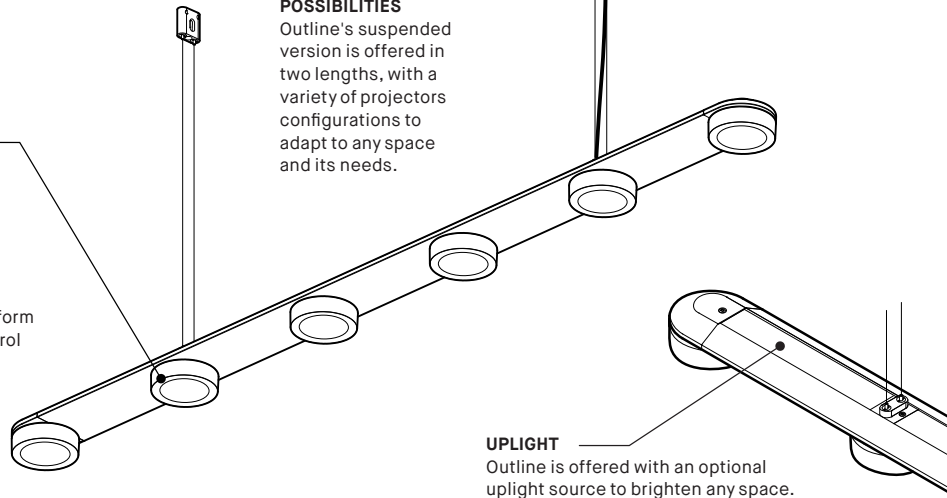

UPLIGHT
Outline is offered with an optional uplight source to brighten any space.

PRODUCT SPECIFICATION	PROJECTOR (EACH) LOW — REG	UPLIGHT 54" LOW — REG — HO	UPLIGHT 78" LOW — REG — HO
PERFORMANCE			
SYSTEM WATTAGE	5 W — 8.7 W	15.7 W — 32.3 W — 50.1 W	22.9 W — 47.5 W — 74.5 W
DELIVERED LUMENS (4000K - WHE)	405 LM — 733 LM	1960 LM — 2824 LM — 5580 LM	3005 LM — 5862 LM — 8552 LM
EFFICACY	81 LM/W — 84 LM/W	125 LM/W — 118 LM/W — 111 LM/W	131 LM/W — 123 LM/W — 115 LM/W
OTHER INFORMATIONS			
LUMINAIRE'S WEIGHT (UP TO)		12.1 LBS / 5.5 KG	15.2 LBS / 6.9 KG
L70 (LUMEN MAINTENANCE)	60 000 HRS	60 000 HRS	60 000 HRS

EFFICACY MULTIPLIERS

CRI	CCT	FACTOR PROJ.	FACTOR UPLIGHT
80+	4000K	1.00	1.00
80+	3500K	0.94	0.98
80+	3000K	0.94	0.94
80+	2700K	0.94	0.91
90+	4000K	0.87	0.88
90+	3500K	0.81	0.85
90+	3000K	0.81	0.81
90+	2700K	0.74	0.77

LIGHT DISTRIBUTION

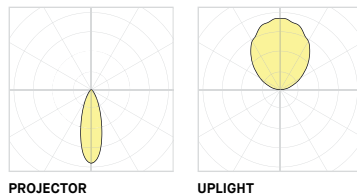

Visit our website for warranty terms and conditions.



TECHNICAL DATA

OUTLINE SUSPENDU FIXE 74901

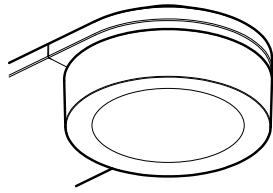

PROJECTEURS FIXES

Les projecteurs sont fixes pour un éclairage direct. Ils peuvent être répartis uniformément le long du luminaire ou regroupés.

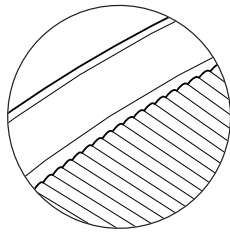

UNE LENTILLE BREVETÉE UNIQUE

La conception innovante de la lentille permet de réduire les éblouissements et de produire un faisceau lumineux uniforme, tout en offrant une bonne efficacité optique.

PAVILLON RECTANGULAIRE

Ce pavillon (REC) est installé en surface sur une boîte de jonction standard de 4 po. Sans quincaillerie visible.

UN DESIGN BREVETÉ EFFICACE ET MINIMALISTE

PAVILLON ROND

Ce pavillon discret jumelé à une boîte de jonction spéciale (3981F, vendue séparément) cache le (ou les) unité(s) d'alimentation DEL dans le plafond. Offert centré avec le luminaire (RCC) ou décentré (ROC). Sans quincaillerie visible.

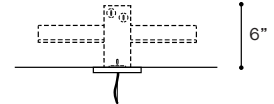

DE NOMBREUSES POSSIBILITÉS

La version suspendue est offerte en deux longueurs avec une grande variété de configurations de projecteurs, afin de s'adapter à de nombreux besoins et espaces.

ÉCLAIRAGE INDIRECT

Outline est offert avec un éclairage indirect optionnel permettant d'harmoniser l'espace.

SPECIFICATION PRODUIT

PROJECTEUR (CHAQUE)

LOW — REG

INDIRECT 54"

LOW — REG — HO

INDIRECT 78"

LOW — REG — HO

PERFORMANCE

PUISSANCE TOTALE

5 W — 8.7 W

15.7 W — 32.3 W — 50.1 W

22.9 W — 47.5 W — 74.5 W

LUMENS RÉELS (4000K-WHE)

405 LM — 733 LM

1960 LM — 2824 LM — 5580 LM

3005 LM — 5862 LM — 8552 LM

EFFICACITÉ

81 LM/W — 84 LM/W

125 LM/W — 118 LM/W — 111 LM/W

131 LM/W — 123 LM/W — 115 LM/W

AUTRE INFORMATIONS

POIDS DU LUMINAIRE (JUSQU'À)

L70 (MAINTENANCE DE LA LUMIÈRE)

> 60 000 H

12.1 LBS / 5.5 KG

> 60 000 H

15.2 LBS / 6.9 KG

> 60 000 H

FACTEUR D'EFFICACITÉ

IRC	CCT	FACTEUR PROJ.	FACTEUR INDIRECT
80+	4000K	1.00	1.00
80+	3500K	0.94	0.98
80+	3000K	0.94	0.94
80+	2700K	0.94	0.91
90+	4000K	0.87	0.88
90+	3500K	0.81	0.85
90+	3000K	0.81	0.81
90+	2700K	0.74	0.77

DISTRIBUTION LUMINEUSE

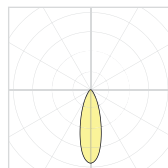

PROJECTEUR

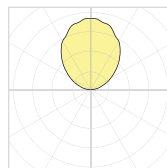

INDIRECT



Visitez notre site Web pour les termes et conditions.



DONNÉES TECHNIQUES

JUNCTION BOX 3981E

PROJECT PROJET
SPEC TYPE
NOTES



ORDERING SPECIFICATION SPÉCIFICATION DE COMMANDE

CODE

MODEL MODÈLE

3981EA	APPROX. 10W MAX EMERGENCY BACKUP POWER
3981EB	APPROX. 5W MAX EMERGENCY BACKUP POWER

PRODUCT CHARACTERISTICS CARACTÉRISTIQUES DU PRODUIT

- DESIGN:** Remote junction box and cover with an emergency backup driver. Features matching wires and labelling to simplify installation. Is required to complete luminaires ordered with EMB remote emergency box option (selected models, refer to specification sheets. Other models possible upon request). Available in several power outputs, selected according to the luminaire power.
- STRUCTURE:** Die-stamped 16 gauge grey painted steel. Knockouts on all 4 sides from 1/2" to 1-1/4".
- CERTIFIED:** c-CSA-us, UL, RoHS, NEMA Type 1, FCC
- CONCEPTION:** Boîte de jonction à distance avec couvercle avec batterie d'urgence intégré. Contient des fils avec couleurs et étiquetage pour simplifier l'installation. Requis pour compléter un luminaire commandée avec l'option EMB (voir pages de spécification pour produits avec l'option EMB. Autres produits possibles sur demande). Disponible en plusieurs puissances, sélectionnées en fonction du luminaire.
- STRUCTURE:** Acier plié de 16 jauge peinturé gris avec coins soudés. Débouchures sur 4 côtés 1/2" à 1-1/4".
- CERTIFIÉ:** c-CSA-us, UL, RoHS, NEMA Type 1, FCC

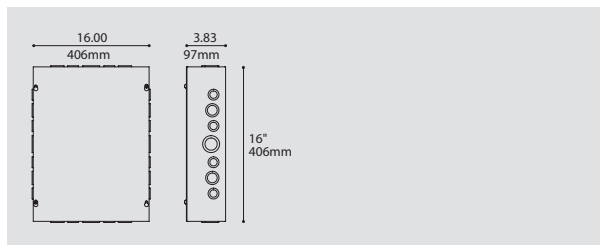

INSTALLATION SUMMARY SOMMAIRE D'INSTALLATION

STEP 1 ÉTAPE 1

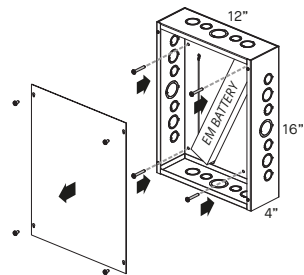

Remove cover and fasten box remotely to a wall or a ceiling.
Enlever le couvercle et fixer la boîte à distance sur un mur ou un plafond.

STEP 2 ÉTAPE 2

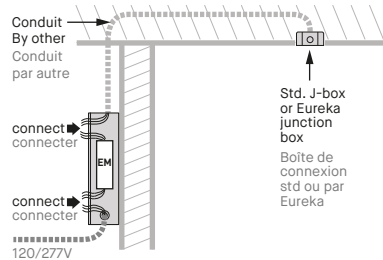

Run conduit from box to junction box of luminaire. Conduit must have a minimum of 5 wires with wire gauge and maximum distance as per EM driver distance chart. Connect EM driver to conduit wires and ac branch circuit. Faites passer le conduit de la boîte EM à la boîte de connexion du luminaire. Consulter le tableau de "distance maximale" disponible dans la feuille d'installation. Branchez la batterie EM avec les fils du conduit ainsi que la ligne 120V ou 277V.

STEP 3 ÉTAPE 3

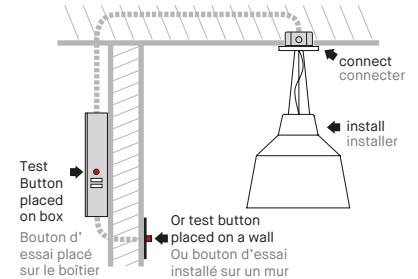

Install luminaire & connect its wires to conduit. Install test button on wall or box (wall plate not supplied). Installer le luminaire & connecter les fils au conduit. Installer le bouton d'essai sur le mur ou boîtier (plaque murale non fournie).

REFER ALSO TO INSTALLATION DRAWING AND EM GUIDE FOR MORE INFORMATION.
CONSULTEZ LE DESSIN D'INSTALLATION ET LE GUIDE EM POUR PLUS D'INFORMATIONS.



SPECIFICATION

3981E REMOTE EMERGENCY BOX KIT - IOTA EM DRIVER

SAFETY GUIDELINES :

- > Follow safety instructions and guidelines of EM battery/driver manufacturer for the specific model.
- > Install by qualified personnel in accordance with the National Electrical Code and local regulations.
- > Turn off power supply before installation or servicing the fixture.

EMB LOCATION :

- > The 3981E box connects to a luminaire ordered with an EMB option (which has specific EM WIRING).
- > Consult our chart for maximum remote distance of EM battery to luminaire leds.
- > Establish desired location for EMB box & EM test button on box or on a wall.

EM Remote Distance Chart
Maximum distance EM battery to Luminaire LEDs (Ft)

MAX EM BOX DISTANCE (Ft)	CONDUIT WIRE GAUGE (AWG)							
	10	12	14	16	18	20	22	
LUMINAIRE DRIVER OUTPUT CURRENT* (Amps)	200mA	350mA	500mA	700mA	1000mA	1400mA	2000mA	3000mA
	1043'	651'	413'	259'	163'	103'	65'	
	596'	372'	236'	148'	93'	59'	37'	
	417'	261'	165'	104'	65'	41'	26'	
	298'	186'	118'	74'	47'	29'	18'	
	209'	130'	83'	52'	33'	21'	13'	
	149'	93'	59'	37'	23'	15'	9'	
	104'	65'	41'	26'	16'	10'	6'	
	70'	43'	28'	17'	11'	7'	4'	

EMB PLACEMENT EXAMPLES :

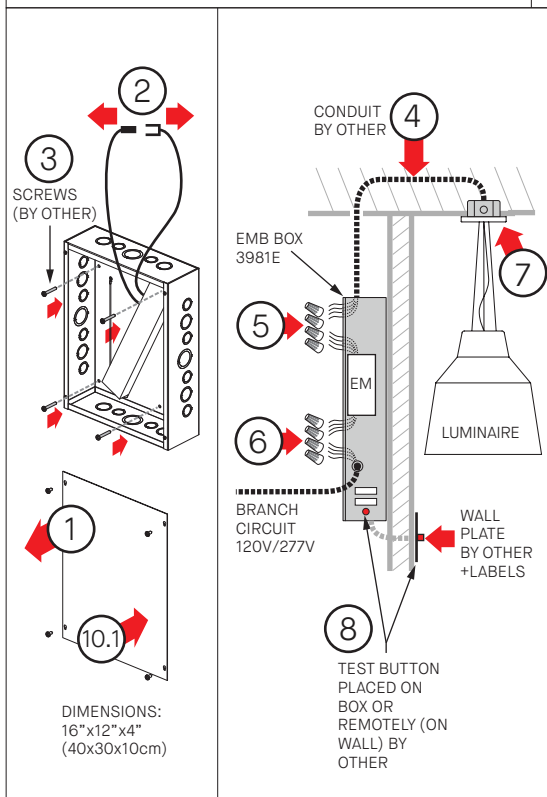
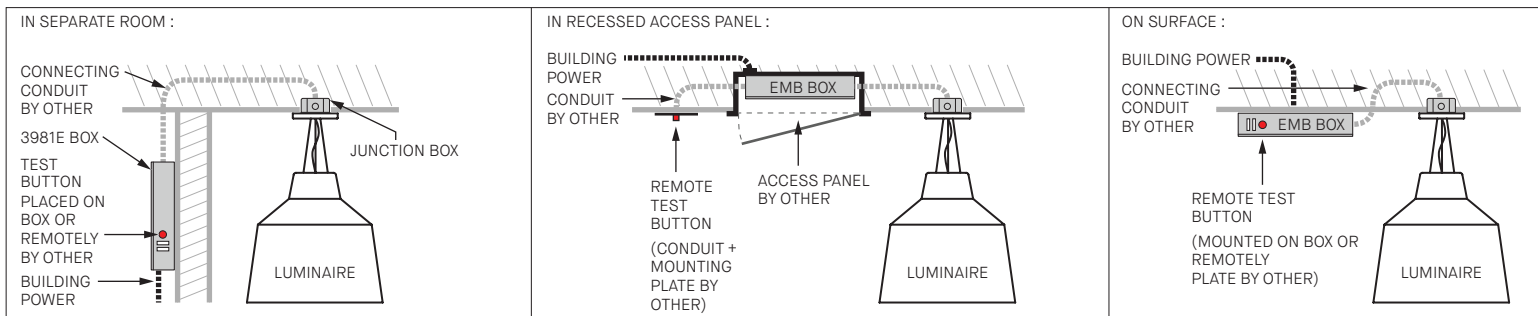

WIRING DIAGRAM:

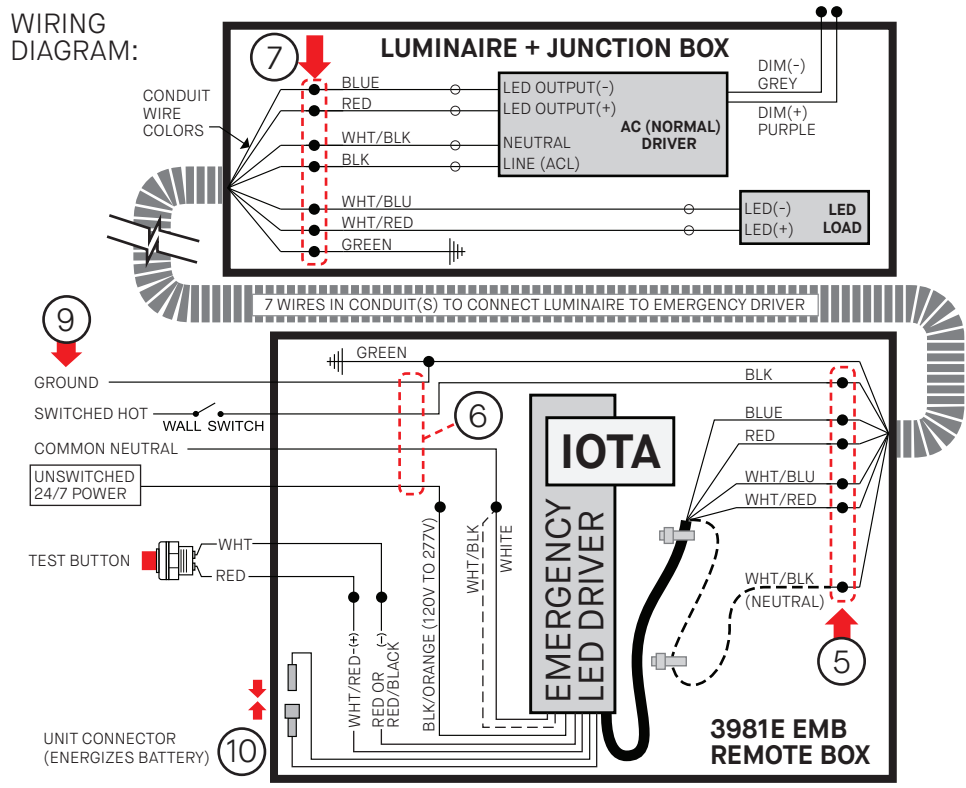

INSTALLATION

- 1 - REMOVE BOX COVER.
- 2 - IF CONNECTED, DISCONNECT THE EM BATTERY 'UNIT CONNECTOR' (WHITE).
- 3 - SCREW BOX TO MOUNTING SURFACE (SCREWS NOT SUPPLIED)
- 4 - RUN CONDUIT FROM EMB BOX TO ELECTRICAL JUNCTION BOX OF LUMINAIRE. CONDUIT MUST HAVE MIN. 7 WIRES AND WIRE GAUGE AS PER DISTANCE CHART.
- 5 - CONNECT CONDUIT WIRES TO EM BATTERY AS PER WIRING DIAGRAM.
CAREFULLY NOTE WHICH WIRE COLORS ARE CONNECTED TOGETHER ON EACH END.
- 6 - CONNECT BATTERY TO AC BRANCH CIRCUIT : GROUND, NEUTRAL, 24/7 UNSWITCHED LINE (HOT) AND SWITCHED LINE (ON SAME CIRCUIT AS LUMINAIRE ON/OFF CONTROL).
- 7 - INSTALL SPECIFIC EM LUMINAIRE, CONNECT WIRES TO CONDUIT USING THE SAME CORRESPONDING COLORS NOTED AT THE EM BATTERY-CONDUIT CONNECTION.
- 8 - INSTALL EM BATTERY TEST BUTTON IN DESIRED LOCATION. WALL PLATE BY OTHER. ADD LABELS "PUSH TO TEST" & CHARGING INDICATOR LIGHT".

- 9 - SWITCH ON AC POWER.
- 10 - JOIN THE EM BATTERY CONVERTOR CONNECTOR. 10.1 - INSTALL BOX COVER.
- 11 - IF EMB IS FAR FROM THE LUMINAIRE, IDENTIFY TO WHICH LUMINAIRE IT IS CONNECTED.

AT THIS POINT POWER SHOULD BE CONNECTED TO BOTH THE AC DRIVER AND THE EMERGENCY DRIVER & TEST/CHARGE LIGHT SHOULD ILLUMINATE, INDICATING BATTERY IS CHARGING.

TESTING & EM DRIVER/BATTERY MAINTENANCE:

CONDUCT A SHORT-TERM DISCHARGE TEST AFTER THE EMERGENCY DRIVER HAS BEEN CHARGED FOR MINIMUM ONE HOUR. CHARGE FOR 24 HOURS BEFORE CONDUCTING A LONG-TERM DISCHARGE TEST.

FOLLOW GUIDELINES FROM THE EM DRIVER/BATTERY MANUFACTURER INSTRUCTIONS FOR THE REQUIRED PERIODIC TESTING AND MAINTENANCE GUIDELINES.

3981E BOÎTE D'URGENCE À DISTANCE - DRIVER EM IOTA

DIRECTIVES DE SÉCURITÉ:

- > Suivre les consignes de sécurité et les directives d'installation du fabricant de la batterie d'urgence.
- > Installer par du personnel qualifié conformément au code électrique national et local.
- > Fermer l'alimentation avant l'installation ou l'entretien.

EMPLACEMENT :

- > Cette boîte 3981E se connecte à un luminaire commandé avec l'option EMB (qui a du filage spécifique).
- > Consulter le tableau pour la distance maximale de la batterie d'urgence aux DELs du luminaire.
- > Déterminer l'emplacement souhaité pour la boîte EMB et le bouton de test d'urgence.

EXEMPLES D'EMPLACEMENT:

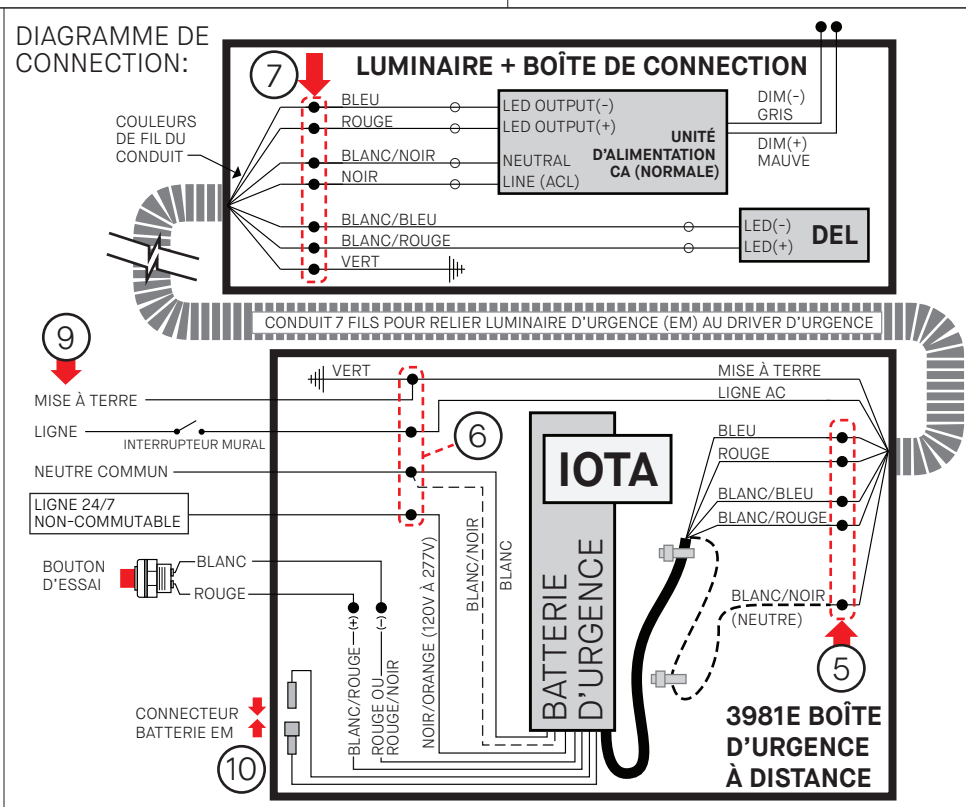
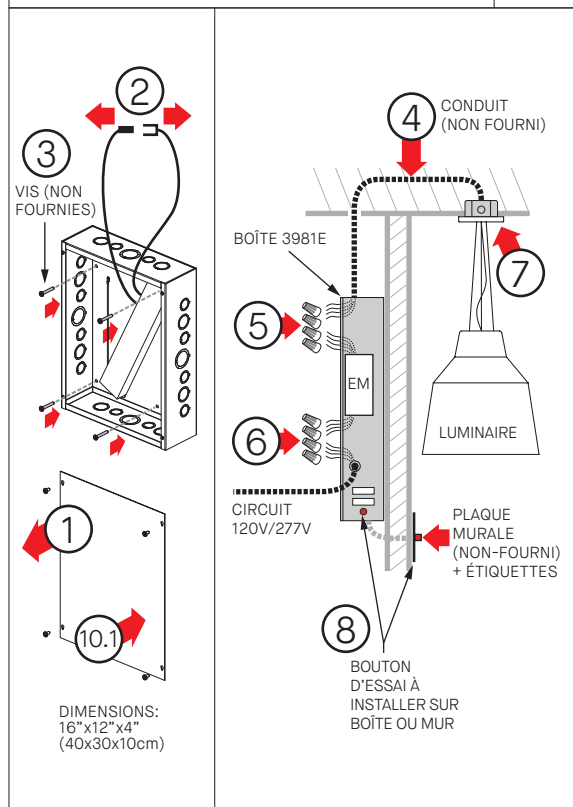
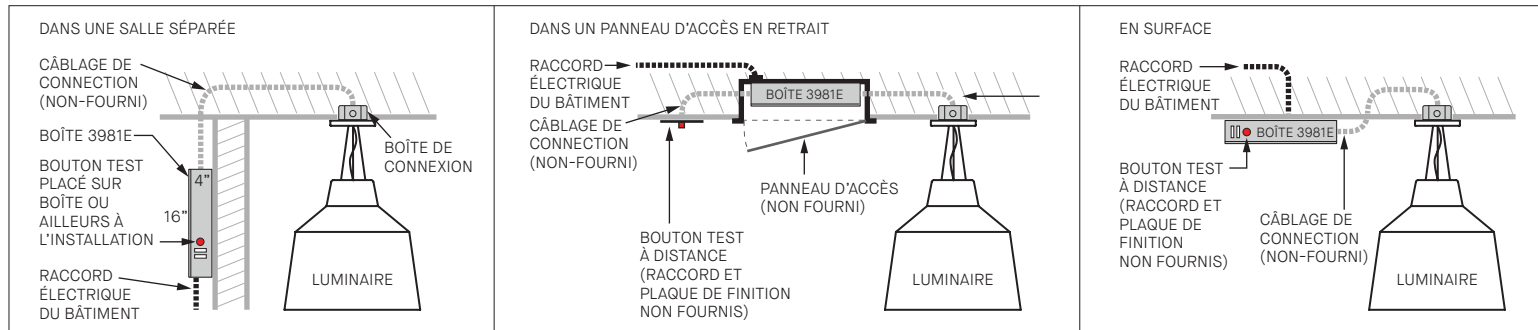

INSTALLATION

- 1 - DÉVISSER LE COUVERCLE.
- 2 - DÉCONNECTER LE CONNECTEUR BLANC DE BATTERIE EM (UNIT CONNECTOR).
- 3 - FIXER LA BOÎTE SUR LE MUR/PALAFOND AVEC VIS (NON FOURNIES)
- 4 - PASSER DU CONDUIT DU EMB VERS LA BOÎTE DE CONNEXION ÉLECTRIQUE DE LUMINAIRE. LE CONDUIT DOIT AVOIR 7 FILS AVEC GAUGE DE FIL SELON CHARTE DE DISTANCE.
- 5 - CONNECTER LES FILS DE CONDUIT À LA BATTERIE EM SELON LE SCHÉMA DE CÂBLAGE.
- 6 - CONNECTER LA BATTERIE AU CIRCUIT DE DÉRIVATION AC (FILS: MISE A LA TERRE, NEUTRE, LIGNE & LIGNE SANS INTERRUPTEUR 24H/7* (*DOIT ETRE LE MEME CIRCUIT QUE LE CONTROLE DU LUMINAIRE)).
- 7 - INSTALLER LUMINAIRE SPÉCIFIQUE EM, CONNECTER LES FILS AU CONDUIT AVEC MÊMES COULEURS CORRESPONDANTES DE LA BATTERIE EM AUX FILS DE CONDUIT.
- 8 - INSTALLEZ LE BOUTON D'ESSAI DE BATTERIE EM DANS L'ENDROIT SOUHAITÉ (PLAQUE MURALE PAR AUTRE). COLLER ÉTIQUETTES "PUSH TO TEST" & CHARGING INDICATOR LIGHT".

- 9 - ALIMENTER LE CIRCUIT AC.
- 10 - JOINDRE CONNECTEUR BLANC DE BATTERIE EM. 10.1 - INSTALLER COUVERCLE DE BOÎTE.
- 11 - SI LE EMB EST LOIN DU LUMINAIRE, IDENTIFIER À QUEL LUMINAIRE IL EST CONNECTÉ.

A CE STADE, L'ALIMENTATION DEVRAIT ÊTRE CONNECTÉE À L'UNITÉ D'ALIMENTATION AC ET LA BATTERIE D'URGENCE ET LA LUMIÈRE DE TEST/CHARGE S'ILLUMINE, INDIQUANT QUE LA BATTERIE SE CHARGE.

ESSAIS & ENTRETIEN DE LA BATTERIE:

FAITES UN TEST DE DÉCHARGE À COURT TERME APRÈS AVOIR CHARGÉ LA BATTERIE D'URGENCE AU MINIMUM UNE HEURE. CHARGEZ 24 HEURES AVANT D'EFFECTUER UN TEST DE DÉCHARGE À LONG TERME.

SUIVRE LES DIRECTIVES DU FABRICANT DE BATTERIE / CONDUCTEUR EM (SITE WEB) POUR LES DIRECTIVES PÉRIODIQUES REQUISES EN MATIÈRE DE TEST ET D'ENTRETIEN.

Charte de distance d'installation EM

Distance maximale entre Batterie d'urgence et DELs du luminaire (Pi)

DISTANCE MAX D'INSTALLATION (Pi)	GAUGE DE FILS DU CONDUIT (AWG)							
	10	12	14	16	18	20	22	
COURANT	200mA	1043'	651'	413'	259'	163'	103'	65'
ALIMENTATION DU LUMINAIRE*	350mA	596'	372'	236'	148'	93'	59'	37'
700mA	417'	261'	165'	104'	65'	41'	26'	18'
1000mA	298'	186'	118'	74'	47'	29'	18'	13'
*Contacter Eureka	1400mA	209'	130'	83'	52'	33'	21'	13'
	2000mA	149'	93'	59'	37'	23'	15'	9'
	3000mA	104'	65'	41'	26'	16'	10'	6'
		70'	43'	28'	17'	11'	7'	4'