

COMPASS 4802-54 / 4802DI-54

PROJECT PROJET
SPEC TYPE
NOTES

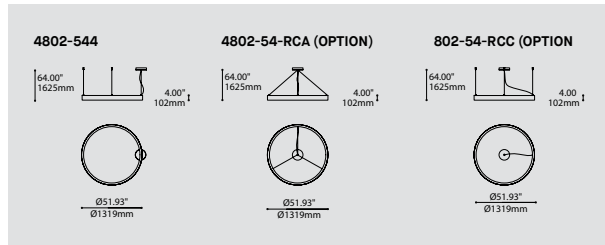

MOUNTING OPTIONS OPTIONS DE MONTAGE

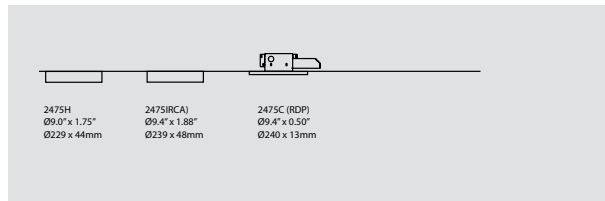

ORDERING SPECIFICATION SPÉCIFICATION DE COMMANDE

MODEL MODÈLE	CODE
4802-54	COMPASS 54"
4802DI-54	COMPASS UPLIGHT 54"

LIGHT SOURCE SOURCE LUMINEUSE	LED
4802-54 LED	REGULAR OUTPUT
4802DI-54 LED	REGULAR OUTPUT

COLOR TEMPERATURE TEMPÉRATURE DE COULEUR	
27	2700K
30	3000K
35	3500K
40*	4000K

* LONGER LEAD TIME MAY APPLY, PLEASE CONTACT YOUR EUREKA REPRESENTATIVE

COLOR RENDERING INDEX (CRI) INDICE DE RENDU DE COULEUR (IRC)	90
90	90+ CRI

VOLTAGE VOLTAGE	
120V	120 VOLT
277V	277 VOLT

DIMMING OPTION OPTION DE GRADATION	
DV	0-10V DIMMING (120V-277V)
DP	PHASE DIMMING (120V ONLY)

LED DIMMING DRIVER IS STANDARD IN THIS PRODUCT, PLEASE SPECIFY YOUR DIMMING TYPE.

DRIVER POSITION POSITION DU PILOT	
RDP	RECESSED DRIVER* 3981D ACCESSORY IS REQUIRED

CABLE CÂBLE	AC
AC	AIRCRAFT MOUNTING & CLEAR CABLE, FIELD ADJUSTABLE

CABLE LENGTH LONGUEUR DE CÂBLE	
60	60" AIRCRAFT CABLE (STD LENGTH)
**	CUSTOM AIRCRAFT CABLE LENGTH (PLEASE SPECIFY) FOR OVERALL LENGTH PLEASE CONTACT YOUR EUREKA REPRESENTATIVE.

MOUNTING OPTION OPTION DE MONTAGE	
RC	ROUND CANOPY / PAVILLON ROND FOR RCA: 1.88" CANOPY (2475I) FOR RECESSED DRIVER OPTION: 0.50" CANOPY (2475C) FOR STANDARD: 1.75" CANOPY (2475H)

MOUNTING CABLE OPTION OPTION DE MONTAGE DE CÂBLE	
RCA	CENTERED ROUND CANOPY - AIRCRAFT CABLES ANGLED TO CENTER*
RCC	CENTERED ROUND CANOPY - STRAIGHT AIRCRAFT CABLES *NOT AVAILABLE WITH RECESSED DRIVER (RDP)

CANOPY FINISH FINI PAVILLON	WHE
WHE	WHITE FINE TEXTURE

RING FINISH FINI DIFFUSER	WHE
WHE	WHITE FINE TEXTURE

DIFFUSER FINISH FINI DIFFUSEUR	WH
WH	WHITE

ACCESSORY ACCESSOIRE	
3981D	JUNCTION BOX FOR RECESSED DRIVER OPTION

PRODUCT CHARACTERISTICS CARACTÉRISTIQUES DU PRODUIT



- DESIGN:** Marrying simplicity and fineness, the Compass enhances the space with its elegantly shaped luminous halos.
- INSTALLATION:** Easy to install, adjust and level using triple aircraft cables; available with straight or angled cables towards a central canopy.
- LIGHT SOURCE:** Double row of custom designed light engine featuring high performance LED.
- STRUCTURE:** Seamlessly finished, rolled aluminum extrusion with highly reflective matte white ployester powder coating enclosed with an extruded optical PMMA diffuser snapped in place and finished with an elegant chrome plated joiner.
- CERTIFIED:** c-CSA-us

COMPASS 4802-XX

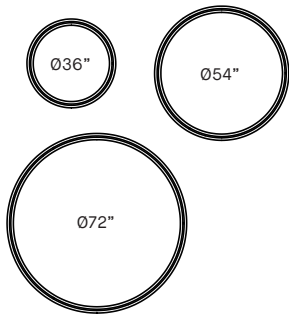
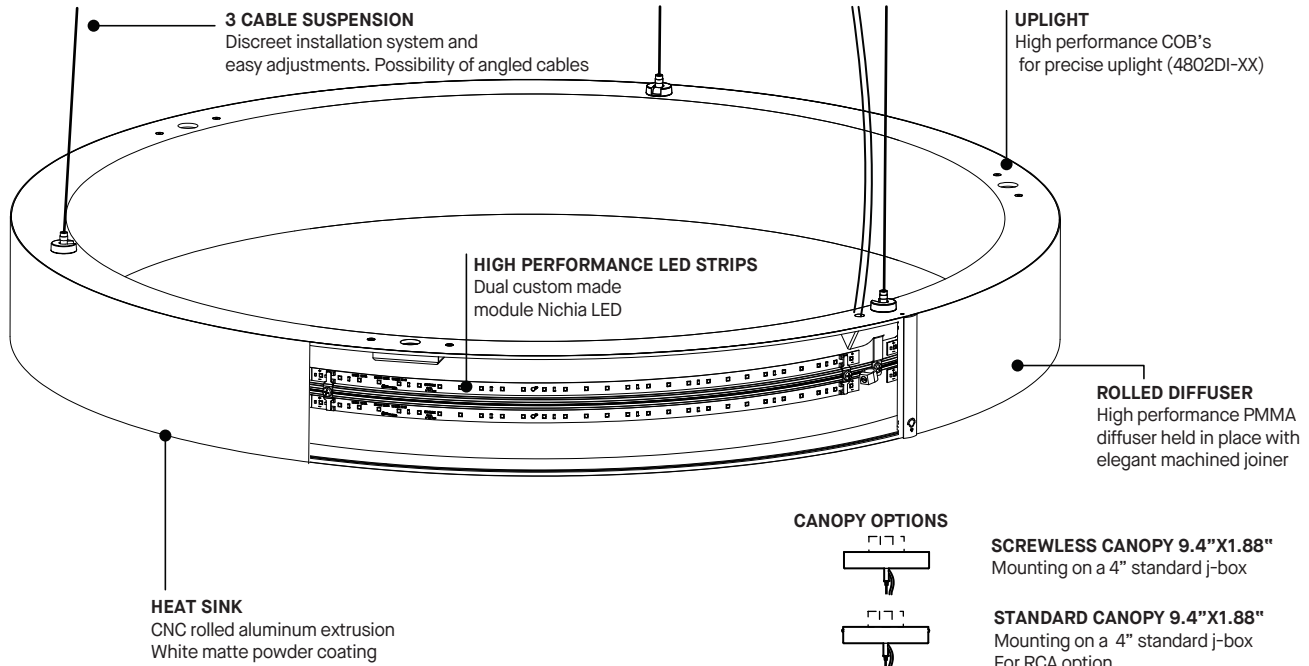

3 VERSATILE SIZES
An infinite number of possible layout
From smallest to the largest space

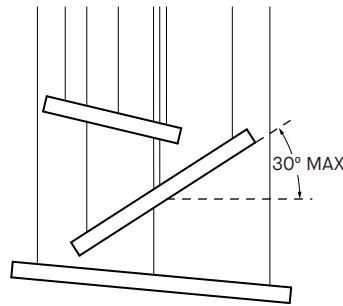

HANG IT STRAIGHT OR ANGLED
Can be installed with a maximum horizontal angle of 30°

CANOPY OPTIONS



SCREWLESS CANOPY 9.4"X1.88"
Mounting on a 4" standard j-box



STANDARD CANOPY 9.4"X1.88"
Mounting on a 4" standard j-box
For RCA option

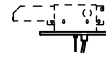

LOW PROFILE CANOPY 9.4"X0.50"
Mounting on Eureka box 3981C (sold separately)
For 4802-36 / 4802-54 DV and 4802-36 DP
Recessed driver for discreet installation

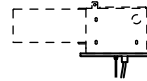

LOW PROFILE CANOPY 9.4"X0.50"
Mounting on Eureka box 3981D (sold separately)
For 4802-72 DV and 4802-54 / 4802-72 DP
For 4802DI-36, 4802DI-54 and 4802DI-72
Recessed driver for discreet installation

CANOPY POSITION



4802-XX
Centered with mounting point
(standard)



4802-XX-RCA
Centered with luminaire /
Centered cables

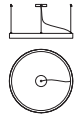

4802-XX-RCC
Centered with luminaire /
Straight cables

PRODUCT SPECIFICATION

	4802-36	4802-54	4802-72
PERFORMANCE			
SYSTEM WATTAGE	54 W	78 W	115 W
DELIVERED LUMENS (4000K)	5215 LM	7766 LM	10906 LM
EFFICACY	109,7 LM/W	99,5 LM/W	94,8 LM/W
OTHER INFORMATION			
LUMINAIRE'S WEIGHT	13 LBS	20 LBS	26 LBS
L70 (LUMEN MAINTENANCE)	60 000 HRS	60 000 HRS	60 000 HRS
MAX. LUMINANCE 45°-90° OF NADIR	4369 CD/M ²	3453 CD/M ²	3245 CD/M ²
LIGHT QUALITY	R9 > 50	R9 > 50	R9 > 50

EFFICACY MULTIPLIERS

CRI	CCT	FACTOR
90+	4000K	1.00
90+	3500K	0.96
90+	3000K	0.92
90+	2700K	0.87

LIGHT DISTRIBUTION

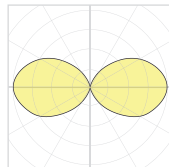

4802-XX



Visit our website for warranty terms and conditions.



TECHNICAL DATA

COMPASS 4802-XX

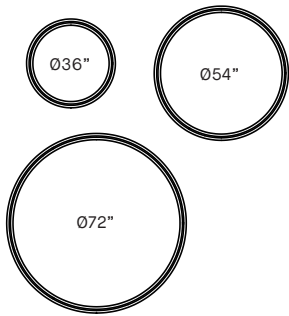
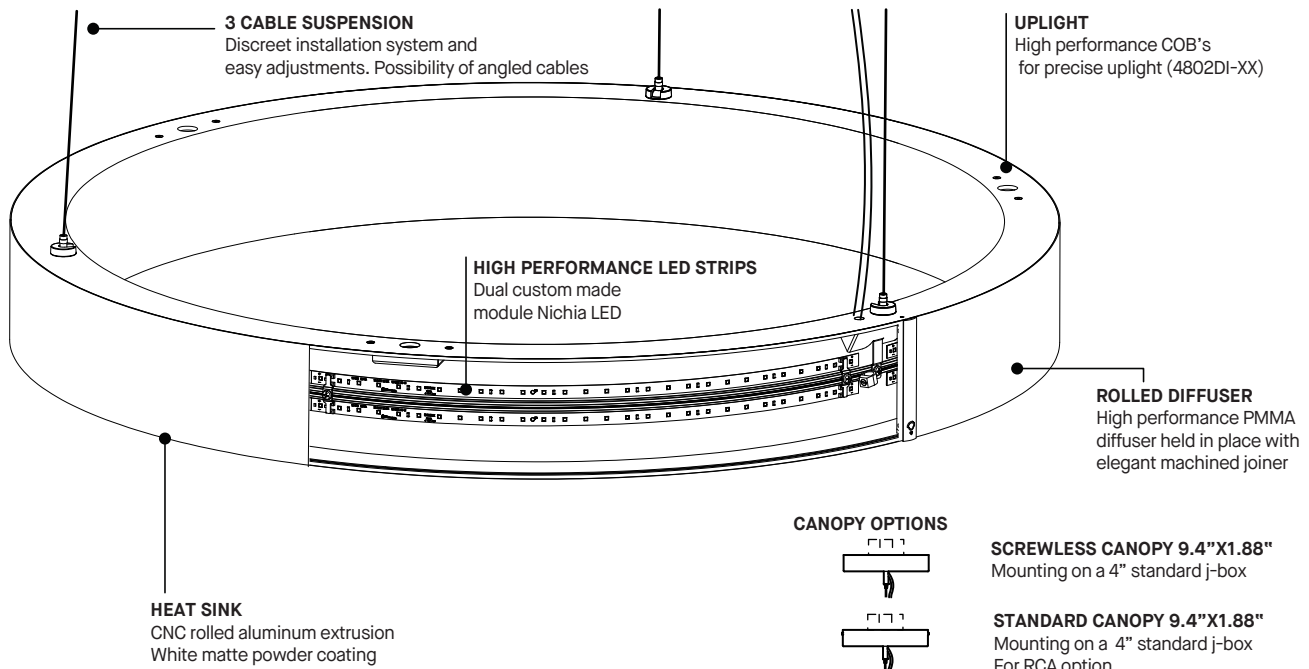

3 VERSATILE SIZES
An infinite number of possible layout
From smallest to the largest space

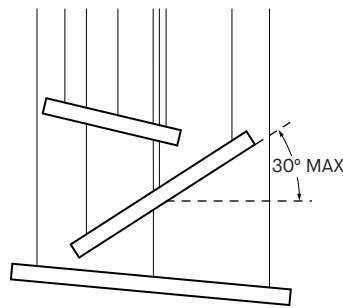

HANG IT STRAIGHT OR ANGLED
Can be installed with a maximum horizontal angle of 30°

CANOPY OPTIONS



SCREWLESS CANOPY 9.4"X1.88"
Mounting on a 4" standard j-box



STANDARD CANOPY 9.4"X1.88"
Mounting on a 4" standard j-box
For RCA option

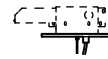

LOW PROFILE CANOPY 9.4"X0.50"
Mounting on Eureka box 3981C (sold separately)
For 4802-36 / 4802-54 DV and 4802-36 DP
Recessed driver for discreet installation

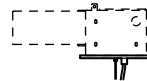

LOW PROFILE CANOPY 9.4"X0.50"
Mounting on Eureka box 3981D (sold separately)
For 4802-72 DV and 4802-54 / 4802-72 DP
For 4802DI-36, 4802DI-54 and 4802DI-72
Recessed driver for discreet installation

CANOPY POSITION



4802-XX
Centered with mounting point (standard)



4802-XX-RCA
Centered with luminaire / Centered cables

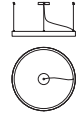

4802-XX-RCC
Centered with luminaire / Straight cables

SPÉCIFICATION PRODUIT

	4802-36	4802-54	4802-72
PERFORMANCE			
PUISSANCE TOTALE	54 W	78 W	115 W
LUMENS RÉELS (4000K)	5926 LM	8825 LM	12393 LM
EFFICACITÉ	109,7 LM/W	113,1 LM/W	107,7 LM/W
AUTRES INFORMATION			
POIDS DU LUMINAIRE	13 LBS	20 LBS	26 LBS
L70 (LUMEN MAINTENANCE)	60 000 HRS	60 000 HRS	60 000 HRS
LUMINOSITÉ MAX. 45°-90° OF NADIR	4369 CD/M ²	3453 CD/M ²	3245 CD/M ²
QUALITÉ DE LA LUMIÈRE	R9 > 50	R9 > 50	R9 > 50

FACTEURS D'EFFICACITÉ

CRI	CCT	FACTEUR
90+	4000K	1.00
90+	3500K	0.96
90+	3000K	0.92
90+	2700K	0.87

DISTRIBUTION LUMINEUSE

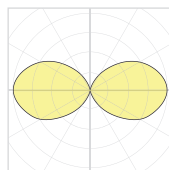

4802-XX



Visitez notre site Web pour les termes et conditions.



DONNÉES TECHNIQUES