

SCOUT 4048

PROJECT PROJÉT
SPEC TYPE
NOTES



FINISH FINI



BLKE WHE LGE PGE NBE

OVERALL HEIGHT HAUTEUR HORS TOUT

	LED TRACK 1 CIRCUIT CABLE	LED TRACK 1 CIRCUIT STEM	LED 0.50" CANOPY CABLE	LED 0.50" CANOPY STEM	LED NLIGHT 1.30" CANOPY CABLE	LED NLIGHT 1.30" CANOPY STEM
	2734E	2734E	2471C	2471C	2474H	2474H
4048-6	66.95"	42.95"	69.70"	45.70"	70.50"	46.50"
4048-10	71.20"	47.20"	73.95"	49.95"	74.75"	50.75"
4048-18	78.70"	54.70"	81.45"	57.45"	82.25"	58.25"

MOUNTING OPTIONS OPTIONS DE MONTAGE

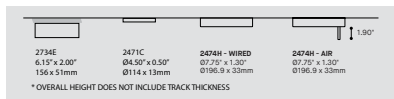

STEM OR CABLE OPTION OPTIONS DE TIGE OU CABLE

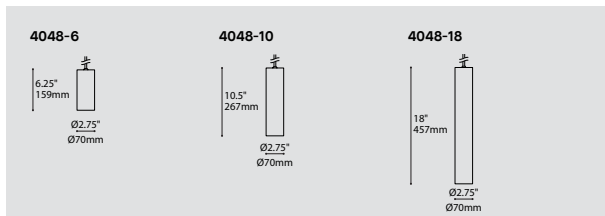
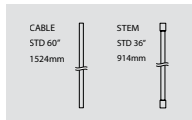

ORDERING SPECIFICATION SPÉCIFICATION DE COMMANDE

CODE

MODEL MODÈLE

4048-6	SCOUT 6"
4048-10	SCOUT 10"
4048-18	SCOUT 18"

LIGHT SOURCE SOURCE LUMINEUSE

LED	REGULAR OUTPUT
LED.HO	HIGH OUTPUT

COLOR TEMPERATURE TEMPÉRATURE DE COULEUR

27*	2700K
30	3000K
35	3500K
40	4000K

* LONGER LEAD TIME MAY APPLY, PLEASE CONTACT YOUR EUREKA REPRESENTATIVE

COLOR RENDERING INDEX (CRI) INDICE DE RENDU DE COULEUR (IRC)

80	80+ CRI
90*	90+ CRI

* LONGER LEAD TIME MAY APPLY, PLEASE CONTACT YOUR EUREKA REPRESENTATIVE

VOLTAGE VOLTAGE

120V	120 VOLT
277V*	277 VOLT

* NOT AVAILABLE FOR TRACK ADAPTOR

CONTROL OPTION OPTION DE CONTRÔLE

DV**	0-10V DIMMING (120V-277V)
DP	PHASE DIMMING (120V ONLY)
NLTAIR2*	NLIGHT AIR CONTROL GEN 2
NLIGHT*	NLIGHT WIRED CONTROL

* REQUIRES RC2 CANOPY.
* EMERGENCY BATTERY NOT AVAILABLE WITH NLIGHT OPTIONS
REFER TO NLIGHT GUIDE AND INSTALLATION SHEET FOR ALL REQUIREMENTS.
** NOT AVAILABLE FOR TRACK ADAPTOR
** FOR NLIGHT AIR AND STEM PLEASE CONTACT YOUR EUREKA REPRESENTATIVE

EMERGENCY BATTERY BATTERIE D'URGENCE

COMPATIBLE WITH RC MOUNTING ONLY. FOR 120-227V, EM DRIVER BOX INCLUDED, INSTALLED REMOTELY. SEE EM GUIDE FOR DETAILS.
WITH DV DIMMING OPTION (FOR 4048-10 & 4048-18) AN ADDITIONAL POWERCABLE WILL DROP FROM CEILING NEXT TO MAIN CABLE.

EMB*	EMERGENCY BATTERY FOR REMOTE BOX
------	----------------------------------

* 3981EA ACCESSORY IS REQUIRED
* NOT AVAILABLE WITH STEM

BEAM ANGLE ANGLE DE FAISCEAU

NA	NARROW (24°)
ME	MEDIUM (45°)

OPTICAL ACCESSORIES ACCESSOIRES OPTIQUES

CLR	CLEAR GLASS LENS
FRO	FROSTED GLASS LENS
HON	HONEYCOMB LOUVER
SOL	SOLITE SOFTENING LENS

STEM OR CABLE TIGE OU CABLE

S10*	3/8" (10MM) STEM, NOT FIELD ADJUSTABLE
C*	BLACK OR WHITE CABLE, FIELD ADJUSTABLE

* FOR WHITE SHADE: WHITE CABLE OR STEM
FOR OTHER SHADE FINISH: BLACK CABLE OR STEM

STEM OR CABLE LENGTH LONGUEUR DE TIGE OU CABLE

36	36" CABLE (STD LENGTH)
60	60" CABLE (STD LENGTH)
**	CUSTOM CABLE LENGTH (PLEASE SPECIFY)
**	CUSTOM CABLE LENGTH (PLEASE SPECIFY)

FOR OVERALL LENGTH, PLEASE CONTACT YOUR EUREKA REPRESENTATIVE

MOUNTING MONTAGE

RC1*	ROUND CANOPY / PAVILLON ROND
RC2	SCREWLESS 0.5" CANOPY (2471C)
	NLIGHT SCREWLESS CANOPY 0.75" X 1.30" (2474H)
	* 3983 ACCESSORY PROVIDED FOR 4048-6 WITH 2471C CANOPY
TA1	TRACK ADAPTOR / ADAPTATEUR DE RAIL
	1 CIRCUIT
	LED DIMMING 120V ADAPTOR (2734E)

TRACK ADAPTOR FINISH FINI ADAPTATEUR DE RAIL (A)

BLK	BLACK
WH	WHITE

(A) FILL IN IF A TRACK ADAPTOR IS SELECTED, OTHERWISE LEAVE EMPTY

CANOPY FINISH FINI PAVILLON (B)

BLKE	BLACK FINE TEXTURE
WHE	WHITE FINE TEXTURE

(B) FILL IN IF A CANOPY IS SELECTED, OTHERWISE LEAVE EMPTY

STRUCTURE FINISH FINI STRUCTURE

BLKE	BLACK FINE TEXTURE
WHE	WHITE FINE TEXTURE
LGE	LIGHT GREY FINE TEXTURE
PGE	PALE GREEN FINE TEXTURE
NBE	NAVY BLUE FINE TEXTURE
RAL*	PLEASE SPECIFY RAL CODE

* LONGER LEAD TIME MAY APPLY, PLEASE CONTACT YOUR EUREKA REPRESENTATIVE

BAFFLE FINISH FINI DÉFLECTEUR

BLKE	BLACK FINE TEXTURE
WHE	WHITE FINE TEXTURE

ACCESSORY ACCESSOIRE

3983	DEEP JUNCTION BOX (PROVIDED FOR 4048-6 WITH CANOPY)
------	---

EMERGENCY BATTERY ACCESSORY ACCESSOIRE BATTERIE D'URGENCE

3981EA	ELECTRICAL BOX FOR EMB EMERGENCY BATTERY
--------	--



SPECIFICATION

SCOUT 4048

QUICKSHIP

PROJECT PROJET

SPEC TYPE

NOTES



FINISH FINI



BLKE

WHE

OVERALL HEIGHT HAUTEUR HORS TOUT

	LED 0.50" CANOPY
MOUNTING	2471C
CABLE & 4048-6	69.70"
CABLE & 4048-10	73.95"
CABLE & 4048-18	81.45"

MOUNTING OPTIONS OPTIONS DE MONTAGE



STEM OR CABLE OPTION OPTIONS DE TIGE OU CABLE

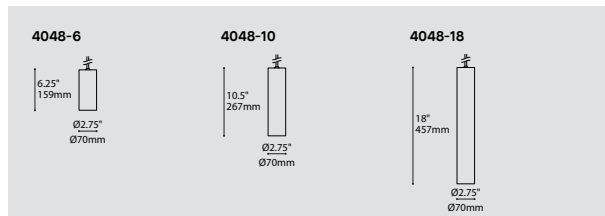
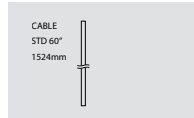

ORDERING SPECIFICATION SPÉCIFICATION DE COMMANDE

CODE

QUICKSHIP

QS5 QUICKSHIP 5 DAYS - MAXIMUM 5 UNITS QUICKSHIP 5 JOURS - MAXIMUM 5 UNITÉS
 QS10 QUICKSHIP 10 DAYS - MAXIMUM 20 UNITS QUICKSHIP 10 JOURS - MAXIMUM 20 UNITÉS

MODEL MODÈLE

4048-6 SCOUT 6"
 4048-10 SCOUT 10"
 4048-18 SCOUT 18"

LIGHT SOURCE SOURCE LUMINEUSE

LED REGULAR OUTPUT
 LED.HO HIGH OUTPUT

COLOR TEMPERATURE TEMPÉRATURE DE COULEUR

30 3000K
 35 3500K
 40 4000K

COLOR RENDERING INDEX (CRI) INDICE DE RENDU DE COULEUR (IRC)

80 80+ CRI

80

VOLTAGE VOLTAGE

120V 120 VOLT
 277V 277 VOLT

DIMMING OPTION OPTION DE GRADATION

DV 0-10V DIMMING (120V-277V)
 DP PHASE DIMMING (120V ONLY)
 LED DIMMING DRIVER IS STANDARD IN THIS PRODUCT, PLEASE SPECIFY YOUR DIMMING TYPE

BEAM ANGLE ANGLE DE FAISCEAU

NA NARROW (24°)
 ME MEDIUM (45°)

OPTICAL ACCESSORIES ACCESSOIRES OPTIQUES

CLR CLEAR GLASS LENS
 FRO FROSTED GLASS LENS
 HON HONEYCOMB LOUVER
 SOL SOLITE SOFTENING LENS

CABLE CABLE

C* BLACK OR WHITE CABLE, FIELD ADJUSTABLE
 *FOR WHITE STRUCTURE: WHITE CABLE, FOR OTHER STRUCTURE FINISH: BLACK CABLE

C

CABLE LENGTH LONGUEUR DE CABLE

60 60" CABLE (STD LENGTH)
 ** CUSTOM CABLE LENGTH (PLEASE SPECIFY)
 FOR OVERALL LENGTH, PLEASE CONTACT YOUR EUREKA REPRESENTATIVE

MOUNTING MONTAGE

RC ROUND CANOPY / PAVILLON ROND
 SCREWLESS 0.5" CANOPY (2471C)

RC

CANOPY FINISH FINI PAVILLON

BLKE BLACK FINE TEXTURE
 WHE WHITE FINE TEXTURE

CYLINDER FINISH FINI CYLINDRE

BLKE BLACK FINE TEXTURE
 WHE WHITE FINE TEXTURE

BAFFLE FINISH FINI DÉFLECTEUR

BLKE BLACK FINE TEXTURE
 WHE WHITE FINE TEXTURE

ACCESSORY ACCESSOIRE

3983 DEEP JUNCTION BOX (PROVIDED FOR 4048-6 WITH CANOPY)

SCOUT 404X FOR ARENA 82X0

PROJECT PROJÉT
SPEC TYPE
NOTES



ADAPTER FINISH FINI DE L'ADAPTATEUR

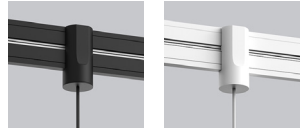

BLKE WHE

SHADE FINISH FINI ABAT-JOUR



BLKE WHE LGE PGE NBE

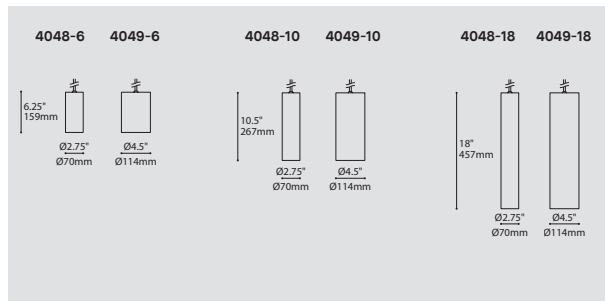

ORDERING SPECIFICATION	SPÉCIFICATION DE COMMANDE	CODE
MODEL MODÈLE		
4048-6	SCOUT 6" Ø2.75"	
4048-10	SCOUT 10" Ø2.75"	
4048-18	SCOUT 18" Ø2.75"	
4049-6	SCOUT 6" Ø4.5"	
4049-10	SCOUT 10" Ø4.5"	
4049-18	SCOUT 18" Ø4.5"	
LIGHT SOURCE SOURCE LUMINEUSE		LEDA
LEDA	SPECIAL OUTPUT FOR ARENA, 8W * TOTAL DC LOAD OF INSTALLED LIGHT SOURCES MUST NOT EXCEED 90W OR 180W DEPENDING ON THE SELECTED OPTION	
COLOR TEMPERATURE TEMPÉRATURE DE COULEUR		
27*	2700K	
30	3000K	
35	3500K	
40	4000K	
*LONGER LEAD TIME MAY APPLY, PLEASE CONTACT YOUR EUREKA REPRESENTATIVE		
COLOR RENDERING INDEX INDICE DE RENDU DE COULEUR (IRC)		
80	80+ CRI	
90*	90+ CRI	
*LONGER LEAD TIME MAY APPLY, PLEASE CONTACT YOUR EUREKA REPRESENTATIVE		
BEAM ANGLE ANGLE DE FAISSEAU		
NA	NARROW (24°)	
ME	MEDIUM (45°)	
OPTICAL ACCESSORIES ACCESSOIRES OPTIQUES		
CLR	CLEAR GLASS LENS	
FRO	FROSTED GLASS LENS	
HON	HONEYCOMB LOUVER	
SOL	SOLITE SOFTENING LENS	
CABLE CÂBLE		C
C	BLACK OR WHITE CABLE, FIELD ADJUSTABLE	
CABLE LENGTH LONGUEUR DE CÂBLE		
24	24" CABLE (STD LENGTH)	
**	CUSTOM CABLE LENGTH (PLEASE SPECIFY)	
MOUNTING MONTAGE		
TAA	ARENA ADAPTOR FOR ARENA SQUARE & RECTANGLE 8220 & ARENA STRAIGHT 8210	
TAB	ARENA ADAPTOR FOR ARENA RING 8200	
ADAPTER FINISH FINI ADAPTATEUR		
BLKE	BLACK FINE TEXTURED	
WHE	WHITE FINE TEXTURED	
POWER CORD FINISH FINI ADAPTATEUR		
BLK	BLACK POWER CORD	
WH	WHITE POWER CORD	
CYLINDER FINISH FINI CYLINDRE		
BLKE	BLACK FINE TEXTURED	
WHE	WHITE FINE TEXTURED	
LGE	LIGHT GREY FINE TEXTURED	
PGE	PALE GREEN FINE TEXTURED	
NBE	NAVY BLUE FINE TEXTURED	
RAL*	PLEASE SPECIFY RAL CODE *LONGER LEAD TIME MAY APPLY, PLEASE CONTACT YOUR EUREKA REPRESENTATIVE	
BAFFLE FINISH FINI DÉFLECTEUR		
BLKE	BLACK FINE TEXTURED	
WHE	WHITE FINE TEXTURED	

PRODUCT CHARACTERISTICS CARACTÉRISTIQUES DU PRODUIT



- DESIGN:** Scout is the simplest of cylinders. The exterior is clean with no visible seams or hardware. Inside, a wealth of technology remains hidden. Machined aluminum tube offered with textured finish. Scout can be specified with 2 baffle finishes.
- INSTALLATION:** Magnetically positioned anywhere on the ARENA for easy on-site installation or reconfiguration of the lighting environment. The adapter has a hook for extra safety.
- LIGHT SOURCE:** High performance LED module mounted on an extruded aluminum heatsink. Designed with narrow or medium beam angle, to meet all applications. Optical choice of clear, frosted or honeycomb lenses available.
- ADAPTER:** Custom designed aluminum base offered in white or black architectural grade finish.
- CERTIFIED:** c-CSA-us

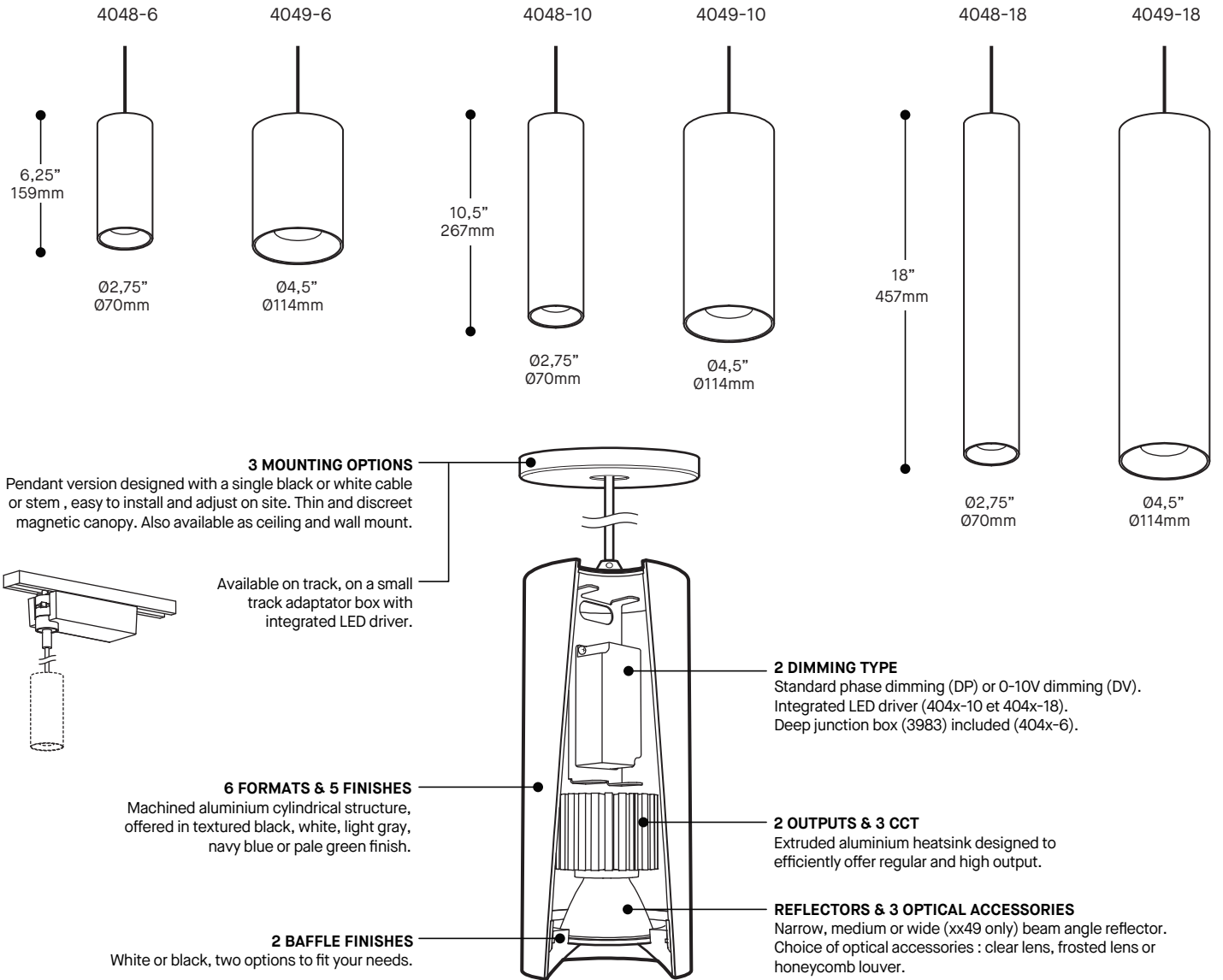

PRODUCT SPECIFICATION	XX48-NA		XX48-ME		XX49-NA		XX49-ME		XX49-WI	
	REG	HO	REG	HO	REG	HO	REG	HO	REG	HO
PERFORMANCE										
SYSTEM WATTAGE	9.5W	13.6W	9.5W	13.6W	13.7W	20W	13.7W	20W	13.7W	20W
DELIVERED LUMENS (4000K)	1051 LM	1425 LM	1051 LM	1425 LM	1394 LM	1907 LM	1509 LM	2070 LM	1472 LM	2021 LM
EFFICACY	110.6LM/W	104.7LM/W	110.6LM/W	104.7LM/W	101.7LM/W	95.4LM/W	110.1M/W	103.5LM/W	107.4M/W	101LM/W
OTHER INFORMATIONS										
BEAM ANGLE	24°		45°		28°		48°		64°	
LUMINAIRE'S WEIGHT	1.44KG / 1.63KG / 1.96KG		1.44KG / 1.63KG / 1.96KG		1.87KG / 2.24KG / 2.75KG		1.87KG / 2.24KG / 2.75KG		1.87KG / 2.24KG / 2.75KG	
L70 (LUMEN MAINTENANCE)	3.16LBS/ 3.58LBS/ 4.32LBS		3.16LBS/ 3.58LBS/ 4.32LBS		4.12LBS/ 4.92LBS/ 6.05LBS		4.12LBS/ 4.92LBS/ 6.05LBS		4.12LBS/ 4.92LBS/ 6.05LBS	
	> 63 600 HRS		> 63 600 HRS		> 63 600 HRS		> 63 600 HRS		> 63 600 HRS	

EFFICACY MULTIPLIERS

CRI	CCT	FACTOR
80+	4000K	1.0
80+	3500K	0.99
80+	3000K	0.97
80+	2700K	0.94
90+	4000K	0.89
90+	3500K	0.86
90+	3000K	0.84
90+	2700K	0.80

LIGHT DISTRIBUTION

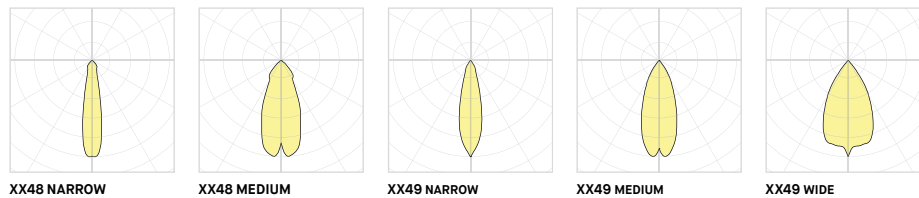

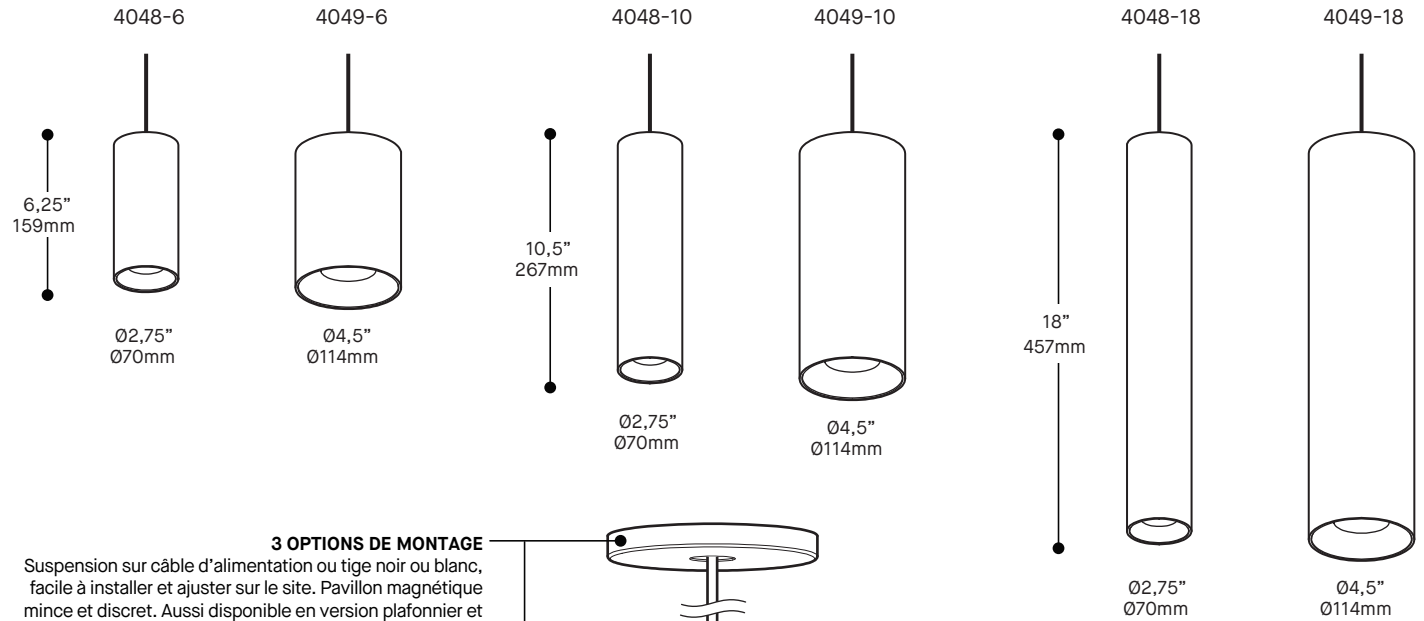

3 OPTIONS DE MONTAGE

Suspension sur câble d'alimentation ou tige noir ou blanc, facile à installer et ajuster sur le site. Pavillon magnétique mince et discret. Aussi disponible en version plafonnier et murale.

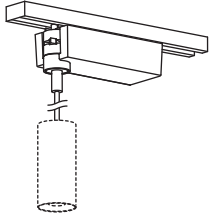

Disponible sur rail, sur une boîte minimaliste avec unité d'alimentation DEL intégrée.

6 FORMATS & 5 FINIS OFFERTS

Structure cylindrique en aluminium usiné, disponible avec finition architecturale finement texturée noire, grise pâle, blanche, bleue marine ou verte pâle.

2 FINIS DE DÉFLECTEUR

Offert en blanc ou noir, deux options pour tous vos besoins.

2 TYPES DE GRADATION

Gradation de type phase (DP) ou 0-10V (DV). Unité d'alimentation intégrée (modèles 404x-10 et 404x-18). Boîte de jonction octogonale profonde 3983 incluse (modèle 404x-6).

2 PUISSANCES & 3 TEMPÉRATURES DE COULEUR

Dissipateur thermique extrudé en aluminium efficace permettant d'offrir deux puissances différentes.

RÉFLECTEURS & 3 ACCESSOIRES OPTIQUES

Réflecteurs offrant un faisceau lumineux étroit, moyen ou large (xx49 seulement). Choix d'accessoires optiques : lentille claire, lentille givrée ou grille en nid d'abeille.

SPÉCIFICATION PRODUIT

SPÉCIFICATION PRODUIT	XX48-NA		XX48-ME		XX49-NA		XX49-ME		XX49-WI	
	REG	HO	REG	HO	REG	HO	REG	HO	REG	HO
PERFORMANCE										
PUISSANCE TOTALE	9.5W	13.6W	9.5W	13.6W	13.7W	20W	13.7W	20W	13.7W	20W
LUMENS RÉELS (4000K)	1051 LM	1425 LM	1051 LM	1425 LM	1394 LM	1907 LM	1509 LM	2070 LM	1472 LM	2021 LM
EFFICACITÉ	110.6LM/W	104.7LM/W	110.6LM/W	104.7LM/W	101.7LM/W	95.4LM/W	110.1M/W	103.5LM/W	107.4M/W	101LM/W
AUTRES INFORMATIONS										
ANGLE DE RAYONNEMENT	24°		45°		28°		48°		64°	
POIDS DU LUMINAIRE	1.44KG / 1.63KG / 1.96KG		1.44KG / 1.63KG / 1.96KG		1.87KG / 2.24KG / 2.75KG		1.87KG / 2.24KG / 2.75KG		1.87KG / 2.24KG / 2.75KG	
	3.16LBS/ 3.58LBS/ 4.32LBS		3.16LBS/ 3.58LBS/ 4.32LBS		4.12LBS/ 4.92LBS/ 6.05LBS		4.12LBS/ 4.92LBS/ 6.05LBS		4.12LBS/ 4.92LBS/ 6.05LBS	
L70 (MAINTENANCE DE LA LUMIÈRE)	> 63 600 H		> 63 600 H		> 63 600 H		> 63 600 H		> 63 600 H	

FACTEUR D'EFFICACITÉ

IRC	CCT	FACTEUR
80+	4000K	1.0
80+	3500K	0.99
80+	3000K	0.97
80+	2700K	0.94
90+	4000K	0.89
90+	3500K	0.86
90+	3000K	0.84
90+	2700K	0.80

DISTRIBUTION LUMINEUSE

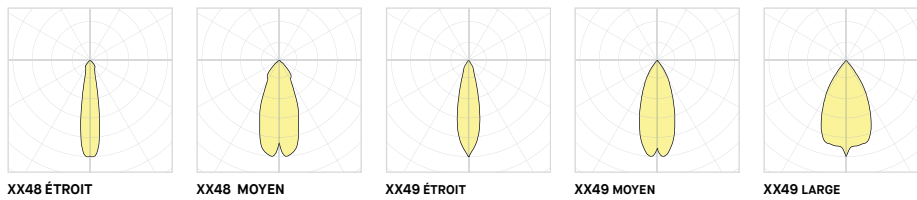

Visitez notre site Web pour les termes et conditions.

JUNCTION BOX 3981E

PROJECT PROJET
SPEC TYPE
NOTES



ORDERING SPECIFICATION SPÉCIFICATION DE COMMANDE CODE

MODEL MODÈLE		
3981EA	APPROX. 10W MAX EMERGENCY BACKUP POWER	
3981EB	APPROX. 5W MAX EMERGENCY BACKUP POWER	

PRODUCT CHARACTERISTICS CARACTÉRISTIQUES DU PRODUIT

- DESIGN:** Remote junction box and cover with an emergency backup driver. Features matching wires and labelling to simplify installation. Is required to complete luminaires ordered with EMB remote emergency box option (selected models, refer to specification sheets. Other models possible upon request). Available in several power outputs, selected according to the luminaire power.
- STRUCTURE:** Die-stamped 16 gauge grey painted steel. Knockouts on all 4 sides from 1/2" to 1-1/4".
- CERTIFIED:** c-CSA-us, UL, RoHS, NEMA Type 1, FCC
- CONCEPTION:** Boîte de jonction à distance avec couvercle avec batterie d'urgence intégré. Contient des fils avec couleurs et étiquetage pour simplifier l'installation. Requis pour compléter un luminaire commandée avec l'option EMB (voir pages de spécification pour produits avec l'option EMB. Autres produits possibles sur demande). Disponible en plusieurs puissances, sélectionnées en fonction du luminaire.
- STRUCTURE:** Acier plié de 16 jauge peinturé gris avec coins soudés. Débouchures sur 4 côtés 1/2" à 1-1/4".
- CERTIFIÉ:** c-CSA-us, UL, RoHS, NEMA Type 1, FCC

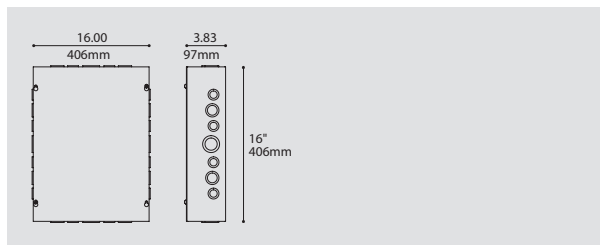

INSTALLATION SUMMARY SOMMAIRE D'INSTALLATION

STEP 1 ÉTAPE 1

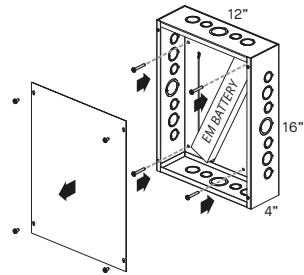

Remove cover and fasten box remotely to a wall or a ceiling.
Enlever le couvercle et fixer la boîte à distance sur un mur ou un plafond.

STEP 2 ÉTAPE 2

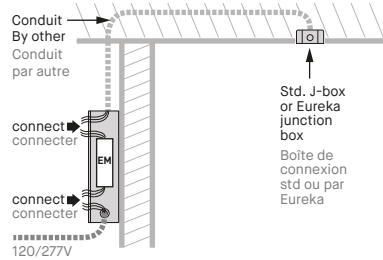

Run conduit from box to junction box of luminaire. Conduit must have a minimum of 5 wires with wire gauge and maximum distance as per EM driver distance chart. Connect EM driver to conduit wires and ac branch circuit. Faites passer le conduit de la boîte EM à la boîte de connexion du luminaire. Consulter le tableau de "distance maximale" disponible dans la feuille d'installation. Branchez la batterie EM avec les fils du conduit ainsi que la ligne 120V ou 277V.

STEP 3 ÉTAPE 3

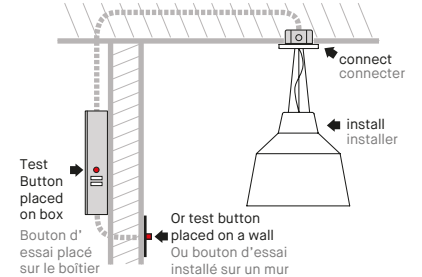

Install luminaire & connect its wires to conduit. Install test button on wall or box (wall plate not supplied). Installer le luminaire & connecter les fils au conduit. Installer le bouton d'essai sur le mur ou boîtier (plaque murale non fournie).

REFER ALSO TO INSTALLATION DRAWING AND EM GUIDE FOR MORE INFORMATION.
CONSULTEZ LE DESSIN D'INSTALLATION ET LE GUIDE EM POUR PLUS D'INFORMATIONS.

3981E REMOTE EMERGENCY BOX KIT - IOTA EM DRIVER

SAFETY GUIDELINES :

- > Follow safety instructions and guidelines of EM battery/driver manufacturer for the specific model.
- > Install by qualified personnel in accordance with the National Electrical Code and local regulations.
- > Turn off power supply before installation or servicing the fixture.

EMB LOCATION :

- > The 3981E box connects to a luminaire ordered with an EMB option (which has specific EM WIRING).
- > Consult our chart for maximum remote distance of EM battery to luminaire leds.
- > Establish desired location for EMB box & EM test button on box or on a wall.

EM Remote Distance Chart
Maximum distance EM battery to Luminaire LEDs (Ft)

MAX EM BOX DISTANCE (Ft)	CONDUIT WIRE GAUGE (AWG)							
	10	12	14	16	18	20	22	
LUMINAIRE DRIVER OUTPUT CURRENT* (Amps)	200mA	350mA	500mA	700mA	1000mA	1400mA	2000mA	3000mA
	1043'	651'	413'	259'	163'	103'	65'	
	596'	372'	236'	148'	93'	59'	37'	
	417'	261'	165'	104'	65'	41'	26'	
	298'	186'	118'	74'	47'	29'	18'	
	209'	130'	83'	52'	33'	21'	13'	
	149'	93'	59'	37'	23'	15'	9'	
	104'	65'	41'	26'	16'	10'	6'	
	70'	43'	28'	17'	11'	7'	4'	

EMB PLACEMENT EXAMPLES :

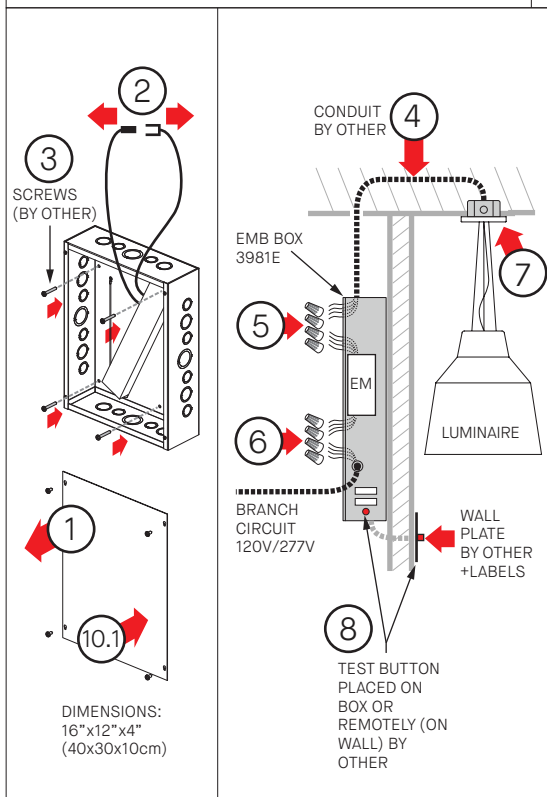
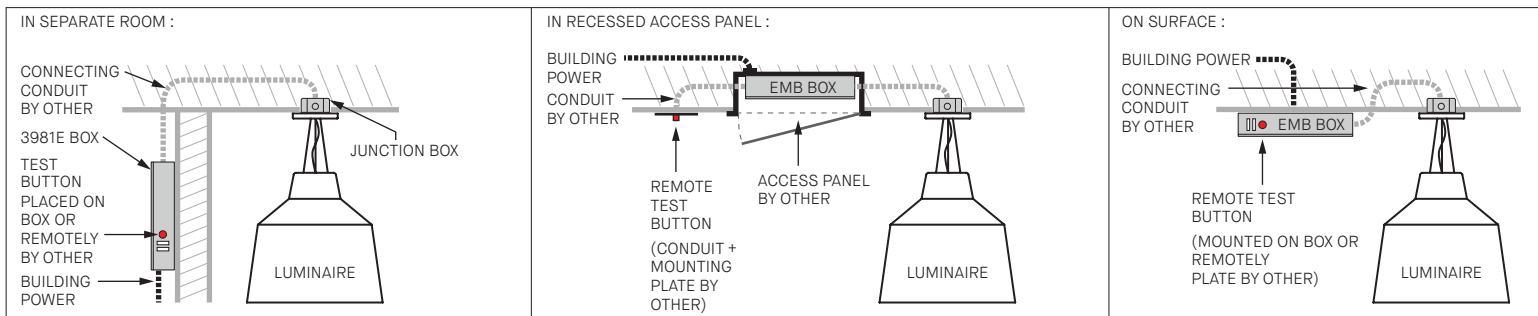

WIRING DIAGRAM:

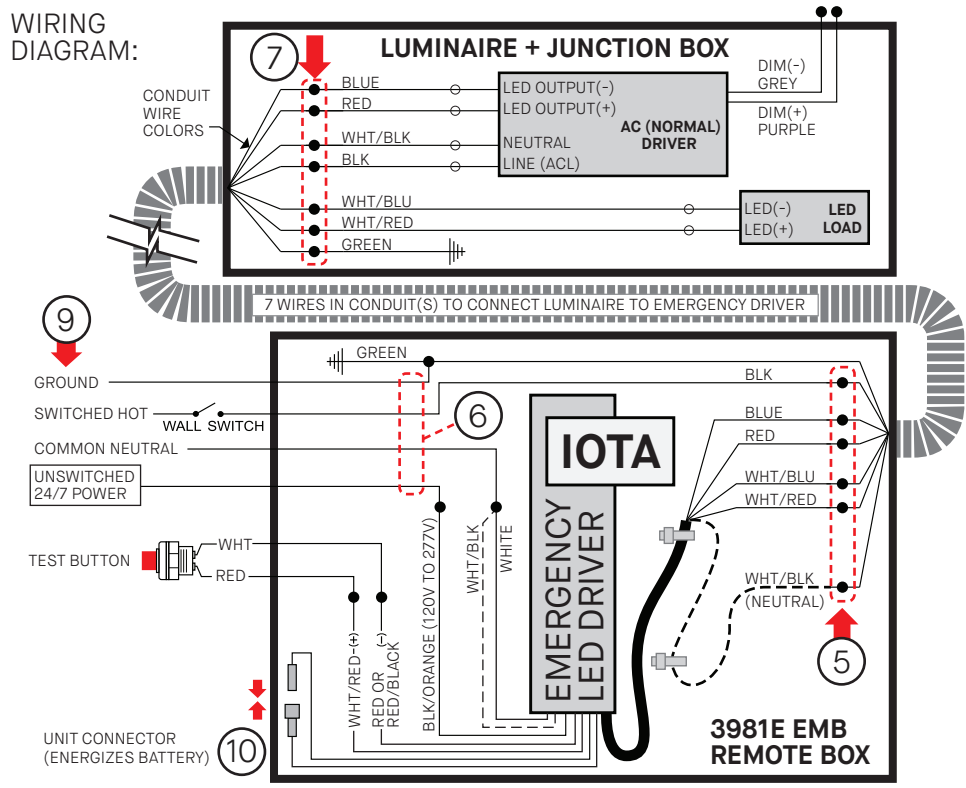

INSTALLATION

- 1 - REMOVE BOX COVER.
- 2 - IF CONNECTED, DISCONNECT THE EM BATTERY 'UNIT CONNECTOR' (WHITE).
- 3 - SCREW BOX TO MOUNTING SURFACE (SCREWS NOT SUPPLIED)
- 4 - RUN CONDUIT FROM EMB BOX TO ELECTRICAL JUNCTION BOX OF LUMINAIRE. CONDUIT MUST HAVE MIN. 7 WIRES AND WIRE GAUGE AS PER DISTANCE CHART.
- 5 - CONNECT CONDUIT WIRES TO EM BATTERY AS PER WIRING DIAGRAM.
CAREFULLY NOTE WHICH WIRE COLORS ARE CONNECTED TOGETHER ON EACH END.
- 6 - CONNECT BATTERY TO AC BRANCH CIRCUIT : GROUND, NEUTRAL, 24/7 UNSWITCHED LINE (HOT) AND SWITCHED LINE (ON SAME CIRCUIT AS LUMINAIRE ON/OFF CONTROL).
- 7 - INSTALL SPECIFIC EM LUMINAIRE, CONNECT WIRES TO CONDUIT USING THE SAME CORRESPONDING COLORS NOTED AT THE EM BATTERY-CONDUIT CONNECTION.
- 8 - INSTALL EM BATTERY TEST BUTTON IN DESIRED LOCATION. WALL PLATE BY OTHER. ADD LABELS "PUSH TO TEST" & CHARGING INDICATOR LIGHT".

- 9 - SWITCH ON AC POWER.
- 10 - JOIN THE EM BATTERY CONVERTOR CONNECTOR. 10.1 - INSTALL BOX COVER.
- 11 - IF EMB IS FAR FROM THE LUMINAIRE, IDENTIFY TO WHICH LUMINAIRE IT IS CONNECTED.

AT THIS POINT POWER SHOULD BE CONNECTED TO BOTH THE AC DRIVER AND THE EMERGENCY DRIVER & TEST/CHARGE LIGHT SHOULD ILLUMINATE, INDICATING BATTERY IS CHARGING.

TESTING & EM DRIVER/BATTERY MAINTENANCE:

CONDUCT A SHORT-TERM DISCHARGE TEST AFTER THE EMERGENCY DRIVER HAS BEEN CHARGED FOR MINIMUM ONE HOUR. CHARGE FOR 24 HOURS BEFORE CONDUCTING A LONG-TERM DISCHARGE TEST.

FOLLOW GUIDELINES FROM THE EM DRIVER/BATTERY MANUFACTURER INSTRUCTIONS FOR THE REQUIRED PERIODIC TESTING AND MAINTENANCE GUIDELINES.

3981E BOÎTE D'URGENCE À DISTANCE - DRIVER EM IOTA

DIRECTIVES DE SÉCURITÉ:

- > Suivre les consignes de sécurité et les directives d'installation du fabricant de la batterie d'urgence.
- > Installer par du personnel qualifié conformément au code électrique national et local.
- > Fermer l'alimentation avant l'installation ou l'entretien.

EMPLACEMENT :

- > Cette boîte 3981E se connecte à un luminaire commandé avec l'option EMB (qui a du filage spécifique).
- > Consulter le tableau pour la distance maximale de la batterie d'urgence aux DELs du luminaire.
- > Déterminer l'emplacement souhaité pour la boîte EMB et le bouton de test d'urgence.

EXEMPLES D'EMPLACEMENT:

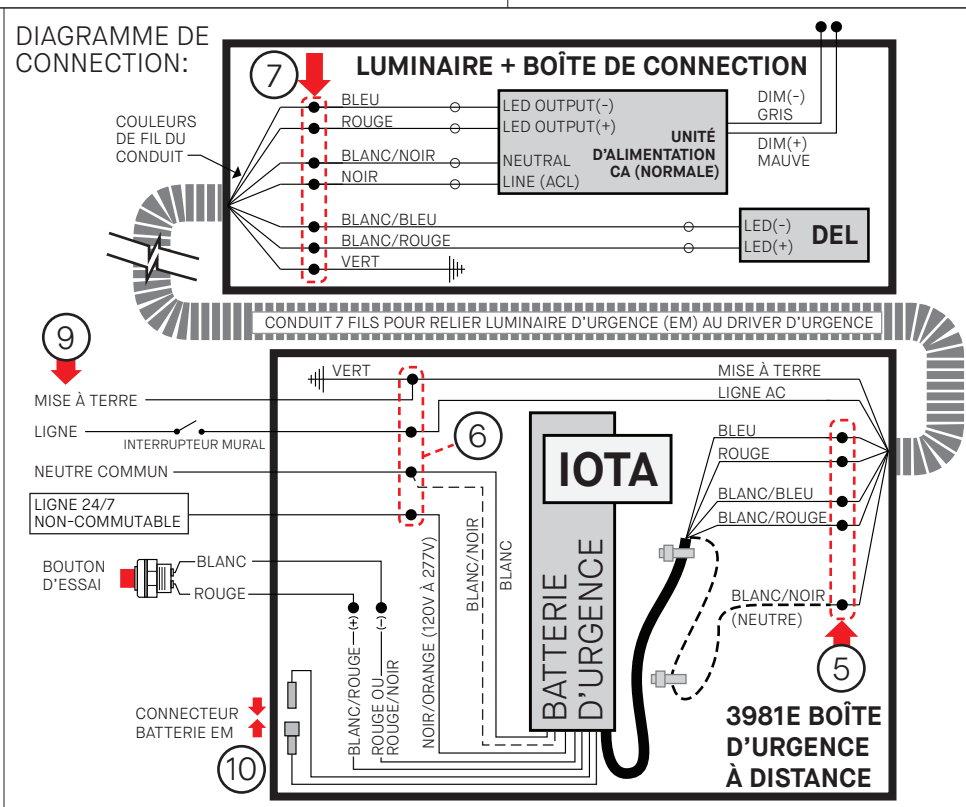
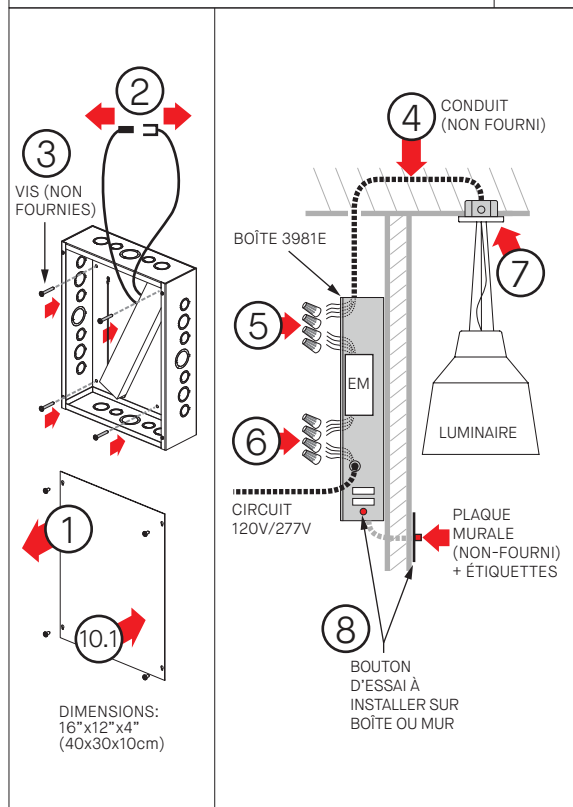
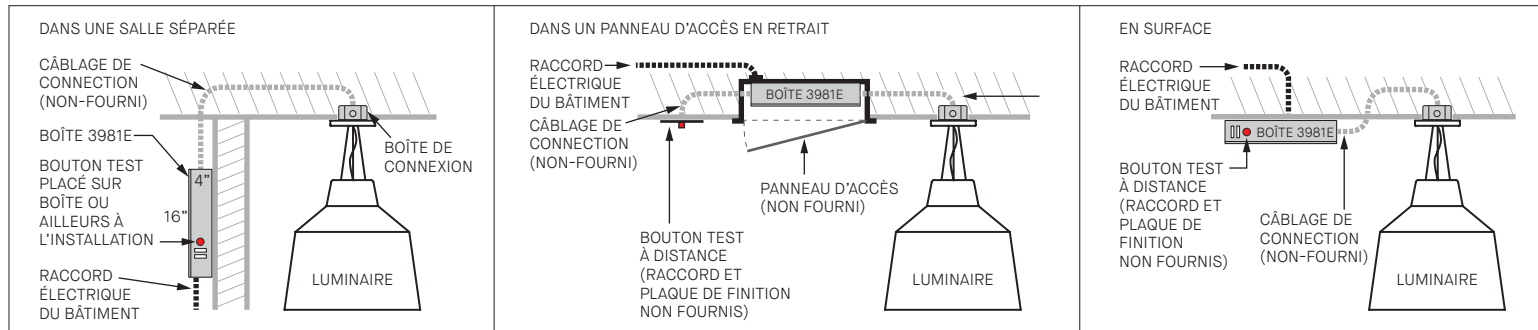

Charte de distance d'installation EM

Distance maximale entre Batterie d'urgence et DELs du luminaire (Pi)

DISTANCE MAX D'INSTALLATION (Pi)	GAUGE DE FILS DU CONDUIT (AWG)							
	10	12	14	16	18	20	22	
COURANT	200mA	1043'	651'	413'	259'	163'	103'	65'
ALIMENTATION DU LUMINAIRE*	350mA	596'	372'	236'	148'	93'	59'	37'
700mA	417'	261'	165'	104'	65'	41'	26'	
1000mA	298'	186'	118'	74'	47'	29'	18'	
*Contacter Eureka	1400mA	209'	130'	83'	52'	33'	21'	13'
	2000mA	149'	93'	59'	37'	23'	15'	9'
	3000mA	104'	65'	41'	26'	16'	10'	6'
		70'	43'	28'	17'	11'	7'	4'

INSTALLATION

- 1 - DÉVISSER LE COUVERCLE.
- 2 - DÉCONNECTER LE CONNECTEUR BLANC DE BATTERIE EM (UNIT CONNECTOR).
- 3 - FIXER LA BOÎTE SUR LE MUR/PALAFOND AVEC VIS (NON FOURNIES)
- 4 - PASSER DU CONDUIT DU EMB VERS LA BOÎTE DE CONNEXION ÉLECTRIQUE DE LUMINAIRE. LE CONDUIT DOIT AVOIR 7 FILS AVEC GAUGE DE FIL SELON CHARTRE DE DISTANCE.
- 5 - CONNECTER LES FILS DE CONDUIT À LA BATTERIE EM SELON LE SCHÉMA DE CÂBLAGE.
- 6 - CONNECTER LA BATTERIE AU CIRCUIT DE DÉRIVATION AC (FILS: MISE A LA TERRE, NEUTRE, LIGNE & LIGNE SANS INTERRUPTEUR 24H/7* (*DOIT ETRE LE MEME CIRCUIT QUE LE CONTROLE DU LUMINAIRE)).
- 7 - INSTALLER LUMINAIRE SPÉCIFIQUE EM, CONNECTER LES FILS AU CONDUIT AVEC MÊMES COULEURS CORRESPONDANTES DE LA BATTERIE EM AUX FILS DE CONDUIT.
- 8 - INSTALLEZ LE BOUTON D'ESSAI DE BATTERIE EM DANS L'ENDROIT SOUHAITÉ (PLAQUE MURALE PAR AUTRE). COLLER ÉTIQUETTES "PUSH TO TEST" & CHARGING INDICATOR LIGHT".

- 9 - ALIMENTER LE CIRCUIT AC.
- 10 - JOINDRE CONNECTEUR BLANC DE BATTERIE EM. 10.1 - INSTALLER COUVERCLE DE BOITE.
- 11 - SI LE EMB EST LOIN DU LUMINAIRE, IDENTIFIER À QUEL LUMINAIRE IL EST CONNECTÉ.

A CE STADE, L'ALIMENTATION DEVRAIT ÊTRE CONNECTÉE À L'UNITÉ D'ALIMENTATION AC ET LA BATTERIE D'URGENCE ET LA LUMIÈRE DE TEST/CHARGE S'ILLUMINE, INDIQUANT QUE LA BATTERIE SE CHARGE.

ESSAIS & ENTRETIEN DE LA BATTERIE:

FAITES UN TEST DE DÉCHARGE À COURT TERME APRÈS AVOIR CHARGÉ LA BATTERIE D'URGENCE AU MINIMUM UNE HEURE. CHARGEZ 24 HEURES AVANT D'EFFECTUER UN TEST DE DÉCHARGE À LONG TERME.

SUIVRE LES DIRECTIVES DU FABRICANT DE BATTERIE / CONDUCTEUR EM (SITE WEB) POUR LES DIRECTIVES PÉRIODIQUES REQUISES EN MATIÈRE DE TEST ET D'ENTRETIEN.