

DROPLET CELESTE 2447-CEL REMOTE JUNCTION BOX SYSTEM

PROJECT PROJÉT
SPEC TYPE
NOTES

CANOPY FINISH FINI PAVILLON



BLKE

GLASS FINISH FINI VERRE



CLR

FRO

REMOTE JUNCTION BOX BOÎTE DE JONCTION ÉLOIGNÉE

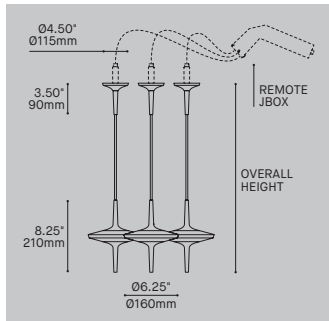

ORDERING SPECIFICATION		SPÉCIFICATION DE COMMANDE		CODE
MODEL MODÈLE				2447-CEL
2447-CEL	DROPLET CELESTE			
CONFIGURATION CONFIGURATION				
101U	SINGLE UNIT	1 CABLE, 1 HEAD	MIN. HEIGHT 16"	
303V	V-SHAPED CLUSTER	3 CABLES, 3 HEADS	MIN. HEIGHT 22"	
303I	INCLINED CLUSTER	3 CABLES, 3 HEADS	MIN. HEIGHT 28"	
304D	DIAMOND CLUSTER	3 CABLES, 4 HEADS	MIN. HEIGHT 40"	
505V	V-SHAPED CLUSTER	5 CABLES, 5 HEADS	MIN. HEIGHT 28"	
505T	TRAPEZE CLUSTER	5 CABLES, 5 HEADS	MIN. HEIGHT 28"	
510D	DIAMOND CLUSTER	5 CABLES, 10 HEADS	MIN. HEIGHT 52"	
510M	MIXED CLUSTER	5 CABLES, 10 HEADS	MIN. HEIGHT 70"	
303L	LEVELED CLUSTER	3 CABLES, 3 HEADS	MIN. HEIGHT 16"	
303S	SPIRALED CLUSTER	3 CABLES, 3 HEADS	MIN. HEIGHT 28"	
306S	SPIRALED CLUSTER	3 CABLES, 6 HEADS	MIN. HEIGHT 46"	
309S	SPIRALED CLUSTER	3 CABLES, 9 HEADS	MIN. HEIGHT 64"	
606S	SPIRALED CLUSTER	6 CABLES, 6 HEADS	MIN. HEIGHT 46"	
612S	SPIRALED CLUSTER	6 CABLES, 12 HEADS	MIN. HEIGHT 82"	
612M	MIXED CLUSTER	6 CABLES, 12 HEADS	MIN. HEIGHT 82"	
618M	MIXED CLUSTER	6 CABLES, 18 HEADS	MIN. HEIGHT 118"	
LIGHT SOURCE SOURCE LUMINEUSE				LED
LED	REGULAR OUTPUT			
COLOR TEMPERATURE TEMPÉRATURE DE COULEUR				
27	2700K			
30	3000K			
35	3500K			
40	4000K			
COLOR RENDERING INDEX (CRI) INDICE DE RENDU DE COULEUR (IRC)				90
90	90+ CRI			
VOLTAGE VOLTAGE				
120V	120 VOLT			
277V	277 VOLT			
DIMMING OPTION OPTION DE GRADATION				DV
DV	0-10V DIMMING (120V-277V)			
CABLE CÂBLE				C
C	BLACK CABLE, CONNECTOR MOUNTED, NOT FIELD ADJUSTABLE			
OVERALL HEIGHT HAUTEUR HORS TOUT				
**	CUSTOM OVERALL HEIGHT (PLEASE SPECIFY)			
OVERALL HEIGHT MEASURED FROM CEILING TO BOTTOM OF FIXTURE CONFIGURATION PATTERN IS SET, ONLY UPPER CABLES ARE INFLUENCED BY OVERALL HEIGHT PLEASE REFER TO CONFIGURATION'S MINIMUM HEIGHT FOR SPECIFICATION				
CANOPY FINISH FINI PAVILLON				BLKE
BLKE	BLACK FINE TEXTURE			
HEAD FINISH FINI TÊTE				BLKE
BLKE	BLACK FINE TEXTURE			
GLASS FINISH FINI VERRE				
CLR	CLEAR GLASS			
FRO	FROSTED GLASS			

PRODUCT CHARACTERISTICS CARACTÉRISTIQUES DU PRODUIT



DROPLET CELESTE 2447-CEL REMOTE JUNCTION BOX SYSTEM

CONFIGURATION CONFIGURATION

101U
Overall Height Min.
16" / 405mm

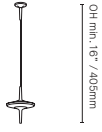

303V
Overall Height Min.
22" / 560mm

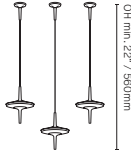

303I
Overall Height Min.
28" / 710mm

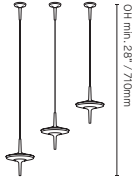

304D
Overall Height Min.
40" / 1015mm

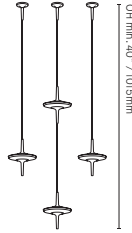

505V
Overall Height Min.
28" / 710mm

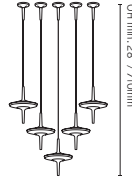

505T
Overall Height Min.
28" / 710mm

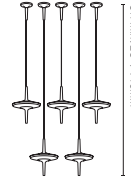

510D
Overall Height Min.
52" / 1320mm

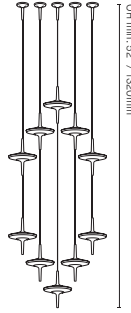

510M
Overall Height Min.
70" / 1780mm

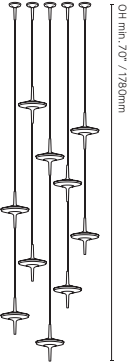

303L
Overall Height Min.
16" / 405mm

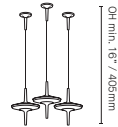

303S
Overall Height Min.
28" / 710mm

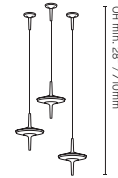

306S
Overall Height Min.
46" / 1170mm

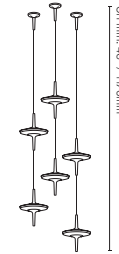

309S
Overall Height Min.
64" / 1625mm

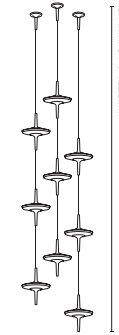

606S
Overall Height Min.
46" / 1170mm

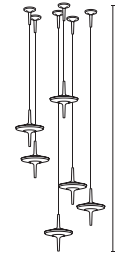

612S
Overall Height Min.
82" / 2080mm

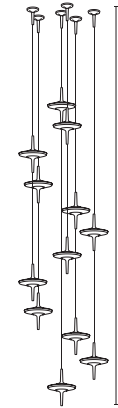

612M
Overall Height Min.
82" / 2080mm

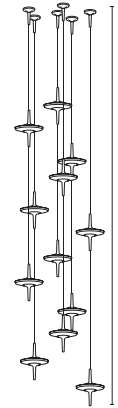

618M
Overall Height Min.
118" / 3000mm

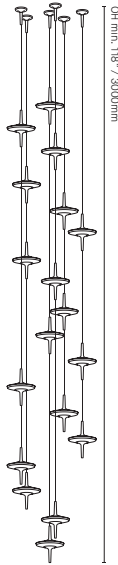

CUSTOM CONFIGURATION

For custom or large-scale configurations, simply contact the factory and we will be pleased to discuss your design requirements.

CONFIGURATION PERSONNALISÉE

Pour des configurations personnalisées ou à grande échelle, veuillez simplement contacter l'usine et nous serons heureux de discuter de vos exigences de conception.

INSTALL IT THE WAY YOU WANT

Every available Celeste Droplet configurations can have it's canopies installed in the ceiling pattern of your choice. It is also possible to order extra individual heads (4010-CEL) to add this extra je ne sais quoi to any existing model.

INSTALLEZ LE COMME VOUS LE VOULEZ

Every available Celeste Droplet configurations can have it's canopies installed in the ceiling pattern of your choice. It is also possible to order extra individual heads (4010-CEL) to add this extra je ne sais quoi to any existing model.

606S
Installation exemple
Circle / Cercle

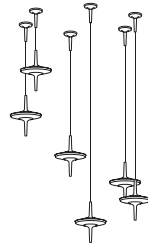

606S
Installation exemple
Line / Ligne

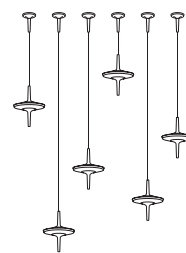

606S
Installation random with extra heads /
Installation aléatoire avec têtes supplémentaire

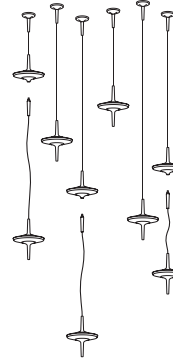

CELESTE

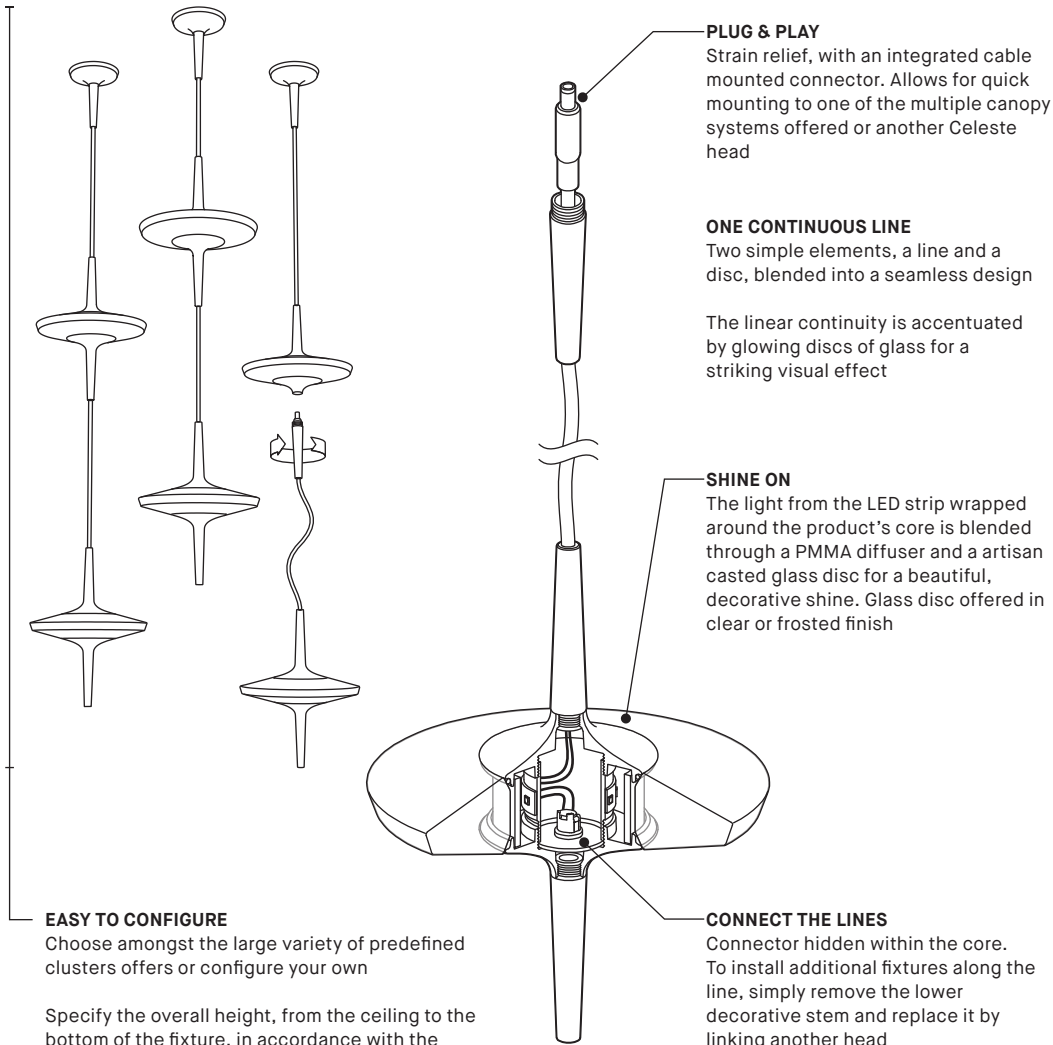

EASY TO CONFIGURE

Choose amongst the large variety of predefined clusters offers or configure your own

Specify the overall height, from the ceiling to the bottom of the fixture, in accordance with the configuration's minimum height and we'll take care of the rest

PLUG & PLAY

Strain relief, with an integrated cable mounted connector. Allows for quick mounting to one of the multiple canopy systems offered or another Celeste head

ONE CONTINUOUS LINE

Two simple elements, a line and a disc, blended into a seamless design

The linear continuity is accentuated by glowing discs of glass for a striking visual effect

SHINE ON

The light from the LED strip wrapped around the product's core is blended through a PMMA diffuser and a artisan casted glass disc for a beautiful, decorative shine. Glass disc offered in clear or frosted finish

CONNECT THE LINES

Connector hidden within the core. To install additional fixtures along the line, simply remove the lower decorative stem and replace it by linking another head

CELESTE SYSTEMS

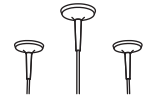

DROPLET CELESTE 2447-CEL

Remote junction box option
Offered with 1, 3, 5, or 6 connector mounted mini canopies



DROPLET CELESTE 2448-CEL

Octagonal junction box mounting
Offered with 1 connector mounted mini canopy and decorative plate covering the junction box

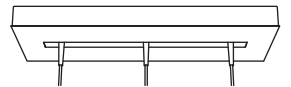

ARRAY CELESTE 4425-CEL

Offered with 3 or 5 connectors

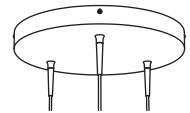

DROP CELESTE 4427-CEL

Offered with 3 or 6 connectors



CELESTE 4010-CEL

Extra head accessory light source
Requires a Celeste system (sold separately)

PRODUCT SPECIFICATION **XXX-CEL-CLR** **XXX-CEL-FRO**

PERFORMANCE		
WATTAGE PER HEAD	3.8W	3.8W
DELIVERED LUMENS PER HEAD (4000K)	200 LM	235LM
OTHER INFORMATION		
LUMINAIRE'S WEIGHT	2.2LBS / 1KG	2.2LBS / 1KG
MAXIMUM HEADS PER CABLE	6 HEADS	6 HEADS
MAXIMUM HEADS ON SYSTEM	20 HEADS	20 HEADS

EFFICACY MULTIPLIERS

CRI	CCT	FACTOR
80	4000K	N/A
80	3500K	N/A
80	3000K	N/A
80	2700K	N/A
90	4000K	1.00
90	3500K	0.95
90	3000K	0.90
90	2700K	0.87

LIGHT DISTRIBUTION

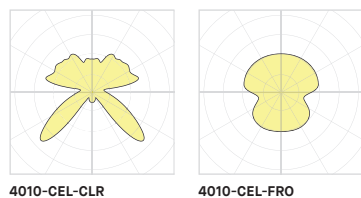

4010-CEL-CLR

4010-CEL-FRO



Visit our website for warranty terms and conditions.



TECHNICAL DATA

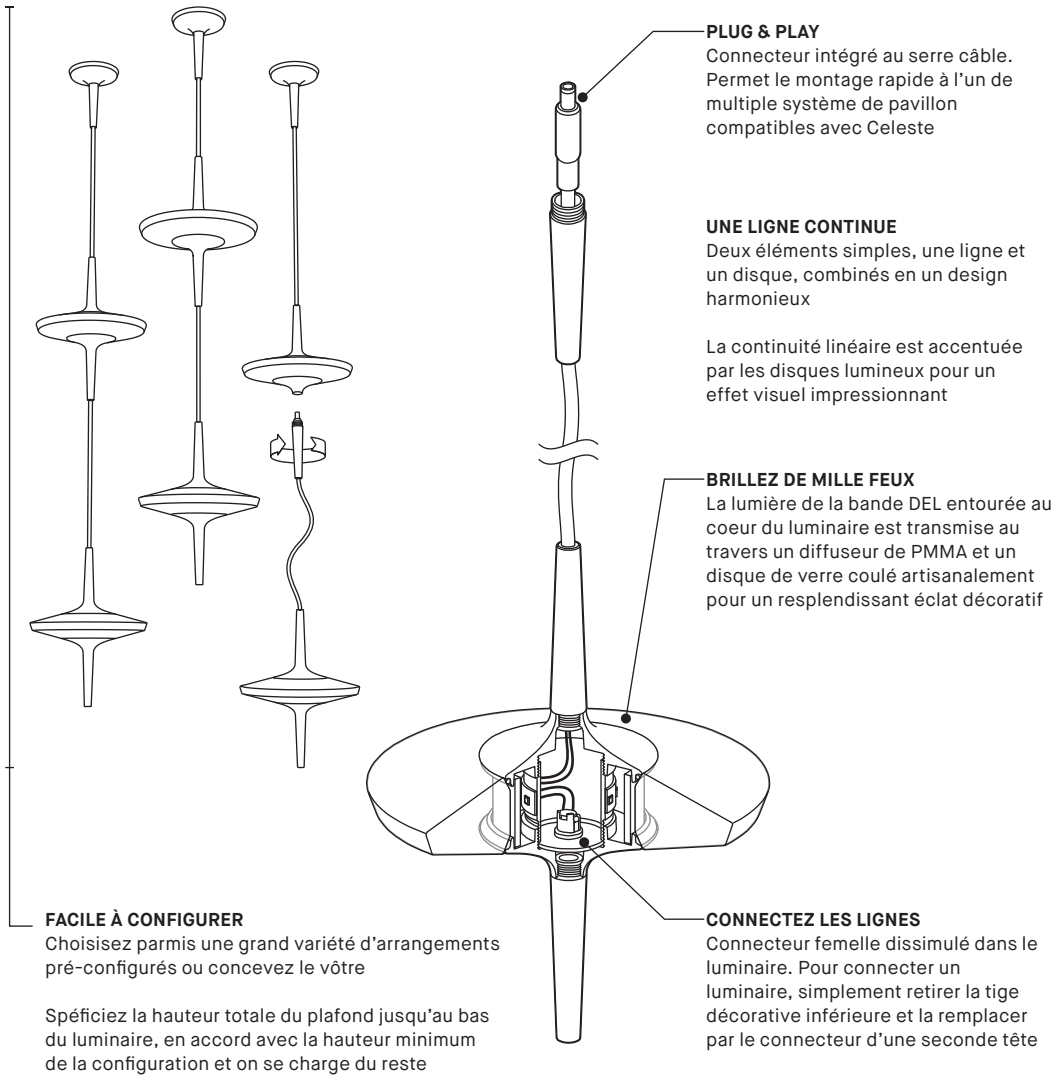

SYSTÈMES CELESTE

DROPLET CELESTE 2447-CEL
Option avec boîtes de jonction éloignée
Offert avec 1, 3, 5, ou 6 mini pavillons munis de connecteurs

DROPLET CELESTE 2448-CEL
Montage sur boîte de jonction octogonale
Offert avec 1 mini pavillon muni d'un connecteur et une plaque décorative couvrant la boîte de jonction

ARRAY CELESTE 4425-CEL
Offert avec 3 ou 5 connecteurs

DROP CELESTE 4427-CEL
Offert avec 3 ou 6 connecteurs

CELESTE 4010-CEL
Accessoire tête lumineuse supplémentaire
Requiert un système Celeste (vendu séparément)

SPÉCIFICATION PRODUIT

	XXX-CEL-CLR	XXX-CEL-FRO
PERFORMANCE		
PUISSANCE PAR TÊTE	3.8W	3.8W
LUMENS RÉELS PAR TÊTE (4000K)	200 LM	235LM
AUTRES INFORMATION		
POIDS PAR TÊTE	2.2LBS / 1KG	2.2LBS / 1KG
MAXIMUM DE TÊTES PAR CÂBLE	6 TÊTES	6 TÊTES
MAXIMUM DE TÊTES SUR LE SYSTÈME	20 TÊTES	20 TÊTES

FACTEUR D'EFFICACITÉ

IRC	CCT	FACTEUR
80	4000K	N/A
80	3500K	N/A
80	3000K	N/A
80	2700K	N/A
90	4000K	1.00
90	3500K	0.95
90	3000K	0.90
90	2700K	0.87

LIGHT DISTRIBUTION

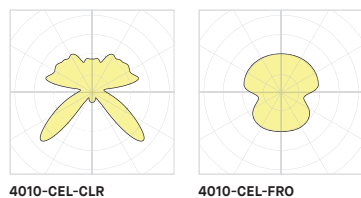

Visitez notre site Web pour les termes et conditions.