

12540-1X1

PROJECT PROJET

SPEC TYPE

NOTES

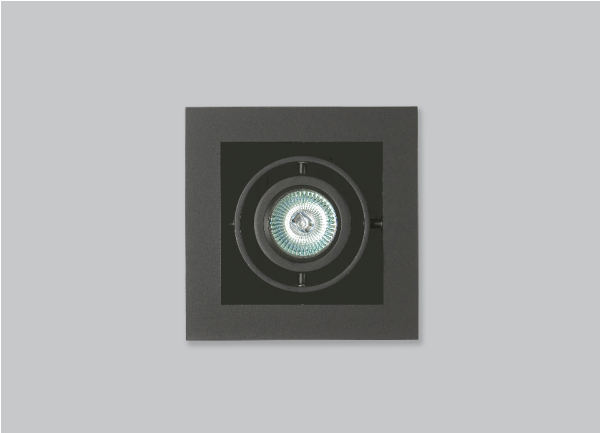

FINISH COMBINATIONS COMBINAISONS DE FINIS



BLK-BLK-BLK



WH-BLK-BLK



WH-WH-WH

159X REMODELING 159X RÉNOVATION

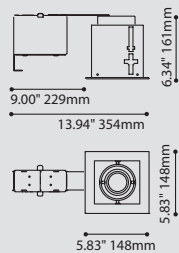

□ 4.9" x 4.9"
(124mm x 124mm)

169X NEW CONSTRUCTION 169X NOUVELLE CONSTRUCTION

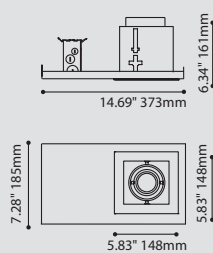

ORDERING SPECIFICATION SPÉCIFICATION DE COMMANDE

CODE

MODEL MODÈLE

12540-1X1 BASS 1X1

12540-1X1

HOUSINGS BOÎTIERS

159X REMODELING
169X NEW CONSTRUCTION

LIGHT SOURCE SOURCE LUMINEUSE

MR16.50.E  50W, HAL, MR16, GU5.3 BASE
MR16LED.16.E  16W MAX., LED, MR16, GU5.3 BASE
LED.4  4W, LED
LED.8  8W, LED
LED.11  11W, LED

COLOR TEMPERATURE TEMPÉRATURE DE COULEUR

FOR LED ONLY

27 2700K
30 3000K
35 3500K
40* 4000K
*LONGER LEAD TIME MAY APPLY, PLEASE CONTACT YOUR EUREKA REPRESENTATIVE

COLOR RENDERING INDEX (CRI) INDICE DE RENDU DE COULEUR (IRC)

FOR LED ONLY

90* 90+ CRI
*MANDATORY FOR LED 4W & 8W

ANGLE BEAM ANGLE DE FAISCEAU

FOR LED ONLY

LED.4 / LED.8

17 17°
48 48°

LED.11

20 20°
40 40°

VOLTAGE VOLTAGE

120V 120 VOLT
277V* 277 VOLT
*NOT AVAILABLE IN LED 8W WITHOUT DV DRIVER OPTION

DIMMING OPTION OPTION DE GRADATION

AVAILABLE WITH LED ONLY

DV 0-10V DIMMING (120V-277V)
DP PHASE DIMMING (120V ONLY)
LED DIMMING DRIVER IS OPTIONAL FOR 12540-1X1 4W & 8W AND STANDARD FOR 12540-1X1 11W, 12540-2X1, 12540-3X1 AND 12540-4X1, PLEASE SPECIFY YOUR DIMMING TYPE.

TRIM FINISH FINI CADRE

BLK BLACK
WH WHITE

RING FINISH FINI ANNEAUX

BLK BLACK
WH WHITE

ENCLOSURE FINISH FINI BOÎTIER

BLK BLACK
WH WHITE

ACCESSORY ACCESSOIRE

19540-1X1 FLUSH™ MOUNTING ACCESSORY (FOR 12540-1X1)

PRODUCT CHARACTERISTICS CARACTÉRISTIQUES DU PRODUIT



The contemporary and functional Bass multiple recessed fixture, features up to four fully directional light sources in both linear and square formats. Available with both standard and high performance Eureka LED modules with optional phase dimming (DP - 120V only) and 0-10V dimming (DV), as well as, MR16 lamp types (LED retrofit or halogen). Dimming is available for all light sources. To maximize design flexibility, the rings and the finish trim of the Bass are available in black or white, while the enclosure is offered in reflective white or discreet black. Using our patented automatically locating mounting clip, Bass is designed for quick installation in both new construction ceilings (169X) or when remodeling (159X) in an existing ceiling. When time is tight the 169X new construction option can be split so that the mounting plate and connection box with quick-connect are shipped in advance of the fixture housing. For a clean look without the hassle of a trim-less installation, the Bass fixture can be installed using our Flush™ mounting accessory (19540).

BASS 12540

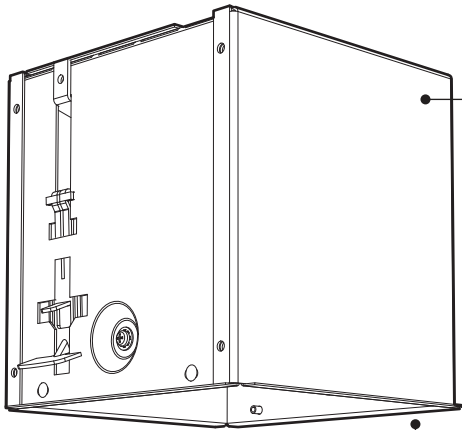

CONTEMPORARY DESIGN
Recessed multiple fixture.
Features 2 fully directional light sources.

LIGHT SOURCES
HAL: 50W
LED: 4W / 8W / 11W
(Optional dimming available with Led)

MANY POSSIBLE FINISH COMBINATIONS:

ENCLOSURE
Discreet black / Reflective white

RING
Black / White
Independant and fully aimable

TRIM
Black / White
Highly decorative, or can be hidden

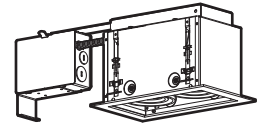

REMODELING OPTION
Unique automatically locating mounting clips for quick installation

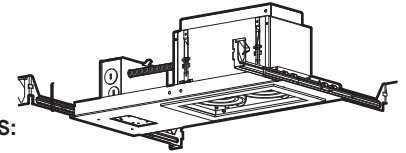

NEW CONSTRUCTION OPTION
Mounting plate available for split shipping in advance



FLUSH™ MOUNTING ACCESSORY
Quick and clever design for a trim-less look

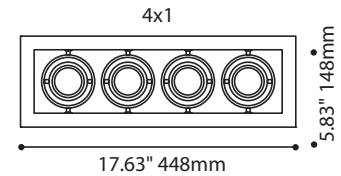
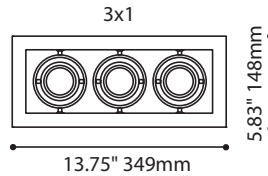
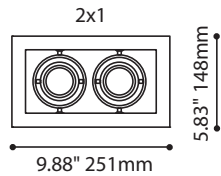
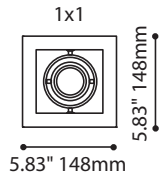
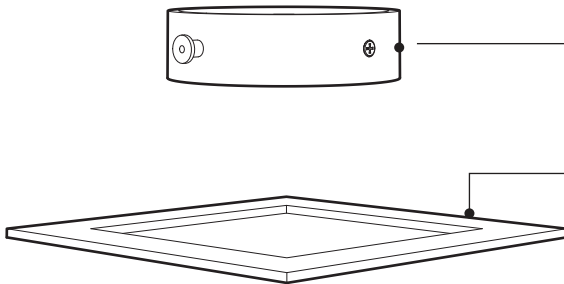

PRODUCT SPECIFICATION

LED 4W

LED 8W

LED 11W

PERFORMANCE

SYSTEM WATTAGE	4W	8W	11W
DELIVERED LUMENS (4000K)	514 LM	947 LM	1629 LM
EFFICACY	100 LM/W	90 LM/W	90 LM/W

OTHER INFORMATIONS

LUMINAIRE'S WEIGHT	12540-1X1: 4.75 LBS / 2.16 KG	12540-2X1: 8.00 LBS / 3.64 KG	12540-3X1: 10.50 LBS / 4.77 KG	12540-4X1: 13.25 LBS / 6.02 KG
L70 (LUMEN MAINTENANCE)	> 60 000 HRS	> 60 000 HRS	> 55 000 HRS	

EFFICACY MULTIPLIERS

CRI	CCT	FACTOR
80+	4000K	1.00
80+	3500K	0.96
80+	3000K	0.92
80+	2700K	0.91
90+	4000K	0.81
90+	3500K	0.77
90+	3000K	0.74
90+	2700K	0.69

LIGHT DISTRIBUTION

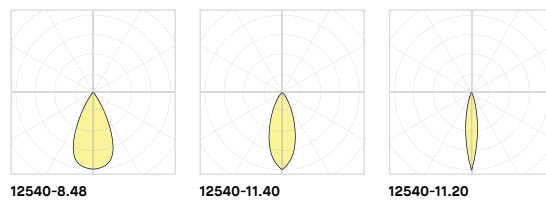

Visit our website for warranty terms and conditions.



TECHNICAL DATA

BASS 12540

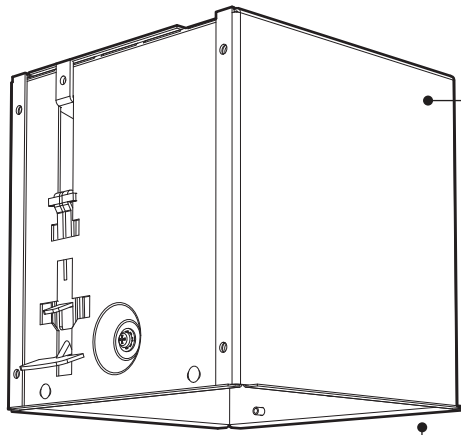

DESIGN CONTEMPORAIN

L'encasté multiple Bass comprend quatre lampes orientables en configuration linéaire ou carrée.

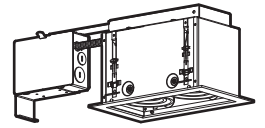

RÉNOVATION

Système breveté exclusif de fixation pour installation rapide

SOURCE LUMINEUSE

HAL: 50W
LED: 4W / 8W / 11W
(DEL offertes avec options de gradation)

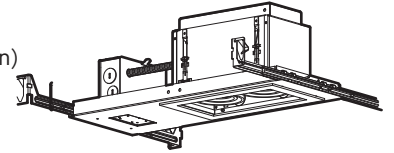

NOUVELLE CONSTRUCTION

La plaque de montage peut être expédié séparément du boîtier, afin d'anticiper l'installation du gypse

PLUSIEURS COMBINAISONS DE FINITION POSSIBLES:

BOITIERS

Noir / Blanc réfléchif

ANNEAUX

Noir discret / Blanc
Indépendants et directionnels

CADRES

Noir / Blanc
Décoratifs ou cachés

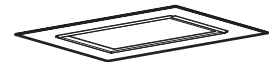

L'ACCESSOIRE DE MONTAGE FLUSH™

Conception rapide et intelligent pour un look sans bordure

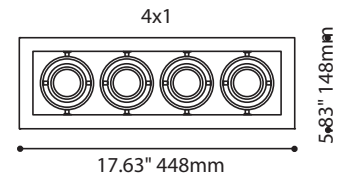
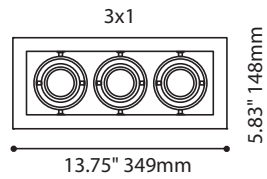
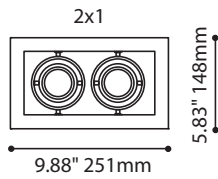
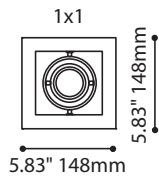
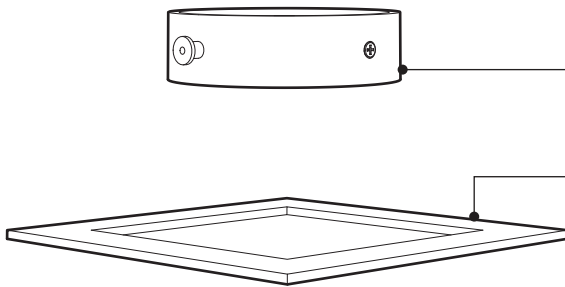

SPÉCIFICATION PRODUIT

LED 4W

LED 8W

LED 11W

PERFORMANCE

PUISSANCE TOTALE	4W	8W	11W
LUMENS RÉELS (4000K)	514 LM	947 LM	1629 LM
EFFICACITÉ	100 LM/W	90 LM/W	90 LM/W

AUTRES INFORMATIONS

POIDS	12540-1X1: 4.75 LBS / 2.16 KG	12540-2X1: 8.00 LBS / 3.64 KG	12540-3X1: 10.50 LBS / 4.77 KG	12540-4X1: 13.25 LBS / 6.02 KG
L70 (MAINTENANCE DE LA LUMIÈRE)	> 60 000 H	> 60 000 H	> 55 000 H	

FACTEUR D'EFFICACITÉ

IRC	CCT	FACTEUR
80+	4000K	1.00
80+	3500K	0.96
80+	3000K	0.92
80+	2700K	0.91
90+	4000K	0.81
90+	3500K	0.77
90+	3000K	0.74
90+	2700K	0.69

DISTRIBUTION LUMINEUSE

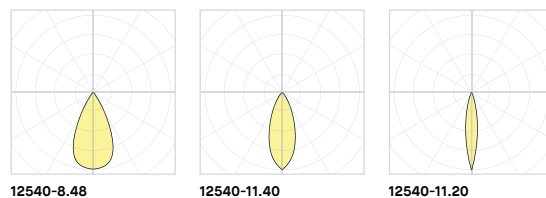

Visitez notre site Web pour les termes et conditions.



DONNÉES TECHNIQUES