

AREA 4816X

QUICKSHIP

PROJECT PROJET

SPEC TYPE

NOTES

4816-24



4816-36



FELT FINISH FINI FEUTRE



FAMILY FAMILLE



4715 (WALL SURFACE)

4715 (CEILING SURFACE)

4816X



4720 (WALL SURFACE)

4720 (CEILING SURFACE)

4821

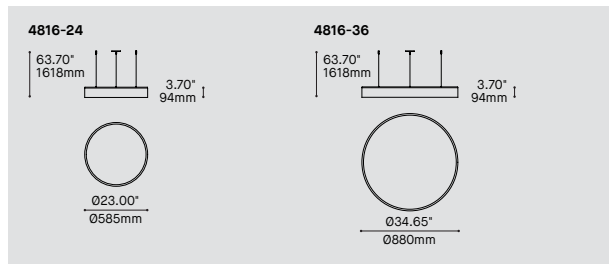

ORDERING SPECIFICATION SPÉCIFICATION DE COMMANDE

CODE

QUICKSHIP

QS5 QUICKSHIP 5 DAYS - MAXIMUM 5 UNITS QUICKSHIP 5 JOURS - MAXIMUM 5 UNITÉS
 QS10 QUICKSHIP 10 DAYS - MAXIMUM 20 UNITS QUICKSHIP 10 JOURS - MAXIMUM 20 UNITÉS

MODEL MODÈLE

4816-24 AREA 24" - ACOUSTIC (NO LIGHT SOURCE)
 4816-36 AREA 36" - ACOUSTIC (NO LIGHT SOURCE)
 4816I-24 AREA 24" - ACOUSTIC WITH INDIRECT LIGHT SOURCE
 4816I-36 AREA 36" - ACOUSTIC WITH INDIRECT LIGHT SOURCE

LIGHT SOURCE SOURCE LUMINEUSE

AVAILABLE FOR 4816I ONLY

LED REGULAR OUTPUT INDIRECT
 LED.HO HIGH OUTPUT INDIRECT

COLOR TEMPERATURE TEMPÉRATURE DE COULEUR

30 3000K
 35 3500K

COLOR RENDERING INDEX (CRI) INDICE DE RENDU DE COULEUR (IRC)

90 90+ CRI
 AVAILABLE FOR 4816I ONLY

VOLTAGE VOLTAGE

120V 120 VOLT
 277V 277 VOLT
 AVAILABLE FOR 4816I ONLY

CONTROL OPTION OPTION DE CONTRÔLE

AVAILABLE FOR 4816I ONLY

DV 0-10V DIMMING (120V-277V)
 DP PHASE DIMMING (120V ONLY)

CABLE CABLE

AC AIRCRAFT MOUNTING & CLEAR CABLE, FIELD ADJUSTABLE

CABLE LENGTH LONGUEUR DE CABLE

60 60" AIRCRAFT CABLE (STD LENGTH)
 ** CUSTOM AIRCRAFT CABLE LENGTH (PLEASE SPECIFY)
 FOR OVERALL LENGTH, PLEASE CONTACT YOUR EUREKA REPRESENTATIVE

CANOPY FINISH FINI PAVILLION

WHE WHITE FINE TEXTURE
 AVAILABLE FOR 4816I ONLY

HOUSING FINISH FINI PAVILLION

WHE WHITE FINE TEXTURE

FELT FINISH FINI FEUTRE

ABF AZURE BLUE FELT	BYF BANANA YELLOW FELT	REF RED FELT
AWF ARCTIC WHITE FELT	CHF CHARCOAL FELT	SGF SILVER GRAY FELT
BBF BASIC BLACK FELT	NBF NAVY BLUE FELT	TGF TITANIUM GRAY FELT
BOF BLOOD ORANGE FELT	OBF OCEAN BLUE FELT	ZFF ZINFANDEL FELT
BTF BATTLESHIP GRAY FELT	PGF PEAR GREEN FELT	

PRODUCT CHARACTERISTICS CARACTÉRISTIQUES DU PRODUIT



Acoustic Material Color Options for Area



Standard colors



ABF
Azure Blue



AWF
Arctic White

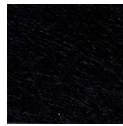

BBF
Basic Black



BOF
Blood Orange

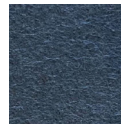

BTF
Battleship Gray



BYF
Banana Yellow



CHF
Charcoal

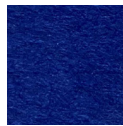

NBF
Navy Blue

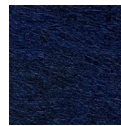

OBF
Ocean Blue

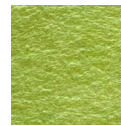

PGF
Pear Green



REF
Red



SGF
Silver Gray



TGF
Titanium Gray

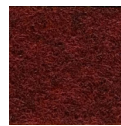

ZFF
Zinfandel

Premium colors



BGF
Bubble Gum



BKF
Bark Brown



DBF
Denim Blue

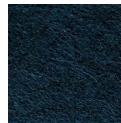

DTF
Deep Teal Green



DYF
Daisy Yellow



GGF
Grass Green



LBF
Light Beige



LGF
Lime Green

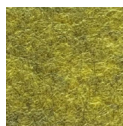

MGF
Moss Green

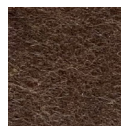

OAF
Oak Brown



PBF
Peanut Brown



PNF
Pinot Noir

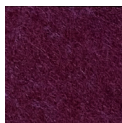

PPF
Plum Purple



SBF
Sky Blue



TOF
Tangerine Orange



TPF
Tulip Purple

- Premium colors carry extended lead times. Additional fees may apply for expedited lead times. Please consult factory.
- Due to the dye process, colors may vary slightly from batch to batch.

AREA ACOUSTIC 4816

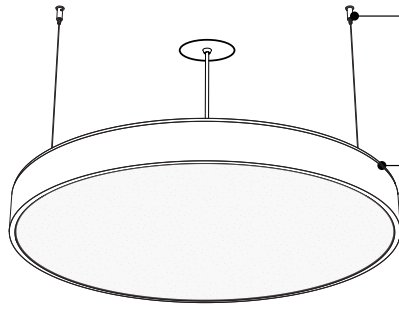

SIMPLIFIED INSTALLATION
Position 3 steel aircraft cables anywhere around a junction box
Easy levelling with adjustable cable grippers

SIMPLE AND CLEAN HOUSING
Precision welded aluminium extrusion
Clean geometry on the outside, structural details on the inside

4816-36 / 4816I-36

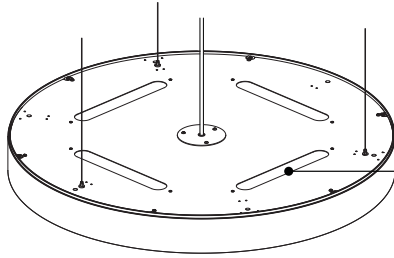

COLORS
Available in 14 standard colors and 16 Premium colors.
For all color options, refer to the Acoustic Material Color Options page.

INDIRECT LIGHTING
Dedicated LED indirect lighting modules (4816I)
Minimum suspension height of 18" (4816I)
Powder-coated steel covers (4816)

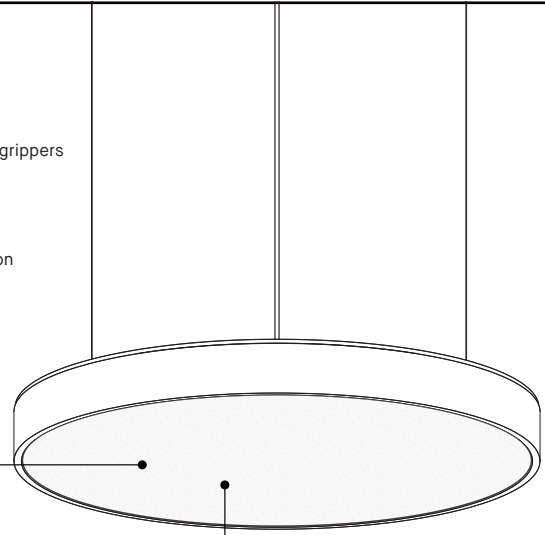

FELT
High density polyester felt panels made from recycled bottles (PET)
The panels are recyclable



NOISE REDUCTION
The center of the product is a large sound absorbing panel that increase acoustic comfort.



Also available in lighting version
See product 4815

CLEANING

A proper and regular cleaning will help extend the lifespan of acoustic products. Remove dust with a vacuum cleaner and light stains with a damp cloth. For greasy and deep stains, a professional dry clean is recommended. Do not use any abrasive, soap, or chemical cleaner.

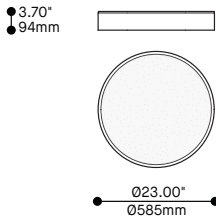

4816-24 / 4816I-24

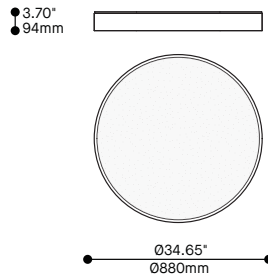

4816-36 / 4816I-36

PRODUCT SPECIFICATION 4816-24 4816-36 4816I-24 4816I-36

PERFORMANCE

SYSTEM WATTAGE	-	-	19.7W / 39.4W	26.1W / 52.2W
DELIVERED INDIRECT LUMENS (4000K)	-	-	2049LM / 4099LM	2695LM / 5391LM
EFFICACY	-	-	104LM/W	103LM/W

OTHER INFORMATIONS

LUMINAIRE'S WEIGHT	11.8LBS / 5.4KG	23.8LBS / 10.8KG	12.7LBS / 5.8KG	24.7LBS / 11.2KG
L70 (LUMEN MAINTENANCE)	N/A	N/A	> 60 000 HRS	> 60 000 HRS
FELT	HIGH DENSITY 9MM POLYESTER FELT			
ACOUSTIC	ACOUSTIC MATERIAL RATED AT 0.75 NRC			
FIRE RATING	ASTM E84-13 (FELT MATERIAL ONLY)			
LIGHT QUALITY			R9 > 50 (90 CRI OPTION)	R9 > 50 (90 CRI OPTION)

EFFICACY MULTIPLIERS

CRI	CCT	FACTOR
90+	4000K	1.00
90+	3500K	0.96
90+	3000K	0.92
90+	2700K	0.87

LIGHT DISTRIBUTION

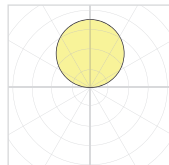

4816I-XX



Visit our website for warranty terms and conditions.



TECHNICAL DATA

AREA ACOUSTIQUE 4816

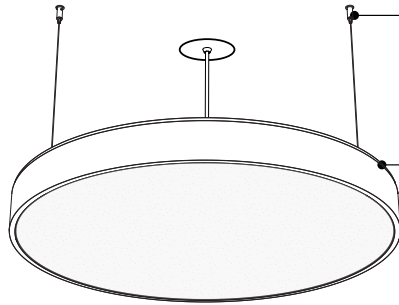

INSTALLATION SIMPLIFIÉE

Situer les 3 câbles de suspension n'importe où autour de la boîte de connexion
Mise à niveau et équilibrage rapide avec serre câbles ajustables

BOÎTIER SOBRE

Extrusion d'aluminium soudée avec précision
Lignes nettes et modernes à l'extérieur, détails structuraux cachés à l'intérieur

4816-36 / 4816I-36

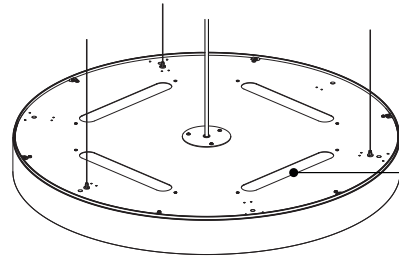

COULEURS

Disponible en 14 couleurs standards et 16 couleurs Premium.
Pour la charte de couleurs consultez la fiche d'options de couleurs

ÉCLAIRAGE INDIRECT

Module LED d'éclairage indirect (4816I)
Suspension minimum de 18" (4816I)
Plaquettes en acier peintes (4816I)

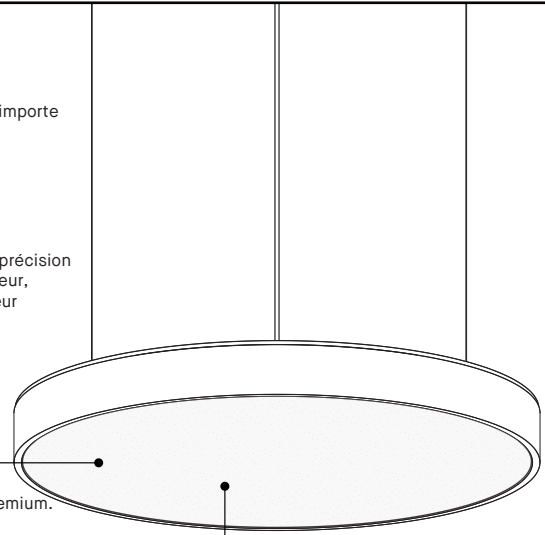

FEUTRE

Panneaux de polyester haute densité faits de bouteilles de plastique recyclées (PET)
Les panneaux sont recyclables



ATTÉNUATION DU BRUIT

Le centre de produit est un grand panneau acoustique qui absorbe le son.



Aussi disponible en version luminaire
Voir le produit 4815

NETTOYAGE

Un nettoyage approprié et régulier contribuera à prolonger la durée de vie des produits acoustiques. Enlever la poussière avec un aspirateur et les taches légères avec un linge humide. Pour les taches importantes ou grassieuses, un nettoyage à sec est recommandé. Ne pas utiliser de produits abrasifs, de savon ou de produits nettoyants chimiques.

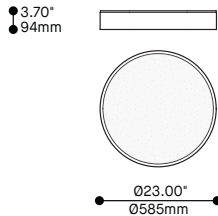

4816-24 / 4816I-24

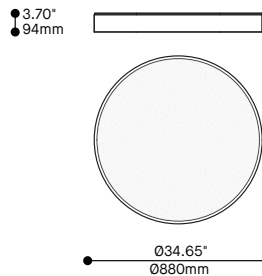

4816-36 / 4816I-36

SPÉCIFICATION PRODUIT

	4816-24	4816-36	4816I-24	4816I-36
PERFORMANCE				
PUISSANCE TOTALE	-	-	19.7W / 39.4W	26.1W / 52.2W
LUMENS RÉELS INDIRECT (4000K)	-	-	2049LM / 4099LM	2695LM / 5391LM
EFFICACITÉ			104LM/W	103LM/W
AUTRES INFORMATIONS				
POIDS DU LUMINAIRE	11.8LBS / 5.4KG	23.8LBS / 10.8KG	12.7LBS / 5.8KG	24.7LBS / 11.2KG
L70 (MAINTENANCE DE LA LUMIÈRE)	N/A	N/A	> 60 000 H	> 60 000 H
FEUTRE ACOUSTIQUE	FEUTRE DE POLYESTER HAUTE DENSITÉ 9MM MATÉRIEL ACOUSTIQUE GRADÉ À 0.75 NRC			
RÉSISTANCE AU FEU	ASTM E84-13 (MATÉRIEL FEUTRE SEULEMENT)			
QUALITÉ DE LA LUMIÈRE			R9 > 50	R9 > 50

FACTEURS D'EFFICACITÉ

CRI	CCT	FACTEUR
90+	4000K	1.00
90+	3500K	0.96
90+	3000K	0.92
90+	2700K	0.87

DISTRIBUTION LUMINEUSE

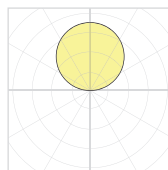

4816I-XX



VisiteznotresiteWebpourlestermesetconditions.



DONNÉES TECHNIQUES