

- Aperture
- Bloom
- Cycle
- Cycle Acoustic
- Mika
- Moonrise
- Mute
- Scout
- Stella
- Tumbler
- Twin
- Valco
- Verner

QUICKSHIP →



Distinctive designs, expedited delivery

Never miss an opportunity because of a tight timeline. Eureka's extensive collection of select luminaires ship in less than 5 days.



WageWorks
Tempe, Arizona, USA

Photo Credit: Halifax Digital Image

Terms & Conditions

- A Quickship order must not exceed quantity of 5 per Quickship product for an order to ship within five (5) days
- A Quickship order must not exceed quantity of 20 per Quickship product for an order to ship within ten (10) days
- 5-day or 10-day lead times are estimated from the date of processing. Does not include weekends/holidays
- All orders received after 4pm EST (1pm PST), on weekends and on holidays, will be processed the next business day
- Incomplete purchase orders will cause delays in order processing and shipment
- Same orders or same project can have multiple different Quickship products
- A project can have multiple Quickship orders as long as orders are placed 15 days apart
- Standard shipping terms & conditions apply

The options detailed within the following pages represent product options that qualify for the Quickship program, additional options are available on standard shipping.

For more details, visit eurekalighting.com

TriHealth Corporate
Administration Offices
Cincinnati, Ohio, USA

Photo Credit: Ryan C. Kurtz



APERTURE 4256

QUICKSHIP
PROJECT PROJET
SPEC TYPE
NOTES



FINISH FINI



WHM

ANTE

FAMILY FAMILLE



4256-12

4256-24

4256-36

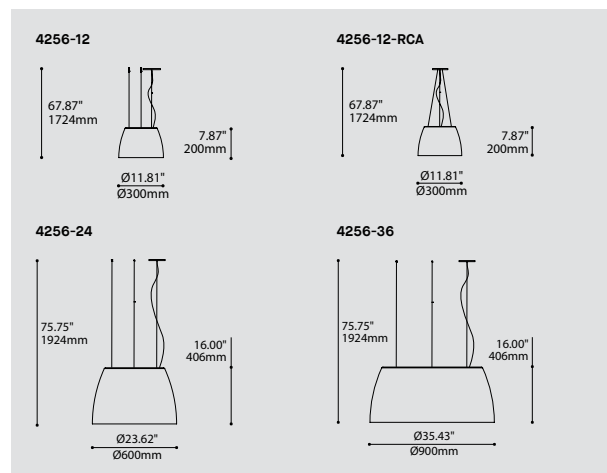

ORDERING SPECIFICATION	SPÉCIFICATION DE COMMANDE	CODE
QUICKSHIP		
QS5	QUICKSHIP 5 DAYS - MAXIMUM 5 UNITS	QUICKSHIP 5 JOURS - MAXIMUM 5 UNITÉS
QS10	QUICKSHIP 10 DAYS - MAXIMUM 20 UNITS	QUICKSHIP 10 JOURS - MAXIMUM 20 UNITÉS
MODEL MODÈLE		
4256-12	APERTURE 12"	
4256-24	APERTURE 24"	
4256-36	APERTURE 36"	
LIGHT SOURCE SOURCE LUMINEUSE		
LED*	REGULAR OUTPUT	LED
	*3983 ACCESSORY IS PROVIDED ONLY FOR 4256-12	
COLOR TEMPERATURE TEMPÉRATURE DE COULEUR		
30	3000K	
35	3500K	
40	4000K	
COLOR RENDERING INDEX (CRI) INDICE DE RENDU DE COULEUR (IRC)		
80	80+ CRI	80
VOLTAGE VOLTAGE		
120V	120 VOLT	
277V	277 VOLT	
DIMMING OPTION OPTION DE GRADATION		
DV	0-10V DIMMING (120V-277V)	
DP	PHASE DIMMING (120V ONLY)	
	LED DIMMING DRIVER IS STANDARD IN THIS PRODUCT. PLEASE SPECIFY YOUR DIMMING TYPE	
CABLE CÂBLE		
AC	AIRCRAFT MOUNTING & CLEAR CABLE, FIELD ADJUSTABLE	AC
CABLE LENGTH LONGUEUR DE CÂBLE		
60	60" AIRCRAFT CABLE (STD LENGTH)	
**	CUSTOM AIRCRAFT CABLE LENGTH (PLEASE SPECIFY)	
	FOR OVERALL LENGTH, PLEASE CONTACT YOUR EUREKA REPRESENTATIVE	
MOUNTING CABLE OPTION OPTION DE MONTAGE DE CÂBLE		
RCA*	CENTERED ROUND CANOPY - AIRCRAFT CABLES ANGLED TO CENTER	
	FOR 4256-12 ONLY	
	IF NO OPTION IS SELECTED, A ROUND CANOPY WITH STRAIGHT AIRCRAFT CABLES WILL BE PROVIDED	
CANOPY FINISH FINI PAVILLON		
WHM	MATTE WHITE	WHM
EXTERIOR SHADE FINISH FINI ABAT-JOUR EXTÉRIEUR		
WHM	MATTE WHITE	
ANTE	ANTHRACITE FINE TEXTURE	
INTERIOR SHADE FINISH FINI ABAT-JOUR INTÉRIEUR		
WHM	MATTE WHITE	WHM
ACCESSORY ACCESSOIRE		
3983	DEEP JUNCTION BOX (PROVIDED FOR 4256-12 AS PER ABOVE)	

ADDITIONAL OPTIONS AVAILABLE ON STANDARD SHIPPING / OPTIONS ADDITIONNELLES DISPONIBLES EN LIVRAISON STANDARD

PRODUCT CHARACTERISTICS CARACTÉRISTIQUES DU PRODUIT

BIM **DIM** **EMB** **IES** **LED**

DESIGN: Hidden inside of an elegant form is a beautiful soft glow of LED illumination that encircles a surprising hollow core. Aperture is available in three formats, small, large and extra-large.

INSTALLATION: Easy to install, adjust and level triple aircraft cable mounting.

LIGHT SOURCE: Aperture features a custom LED light engine that is available with a standard dimming driver.

EXTERIOR FINISH: White or Anthracite matte polyester powder coating.

INTERIOR FINISH: Highly reflective matte white polyester powder coating.

CERTIFIED: c-CSA-us

BLOOM 4269

QUICKSHIP
PROJECT PROJET
SPEC TYPE
NOTES



FINISH FINI



BLKE

WHE

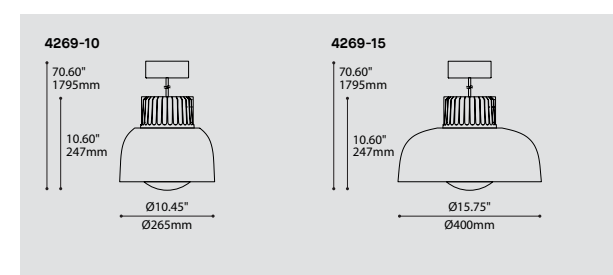

ORDERING SPECIFICATION	SPÉCIFICATION DE COMMANDE	CODE
QUICKSHIP		
QS5	QUICKSHIP 5 DAYS - MAXIMUM 5 UNITS	QUICKSHIP 5 JOURS - MAXIMUM 5 UNITÉS
QS10	QUICKSHIP 10 DAYS - MAXIMUM 20 UNITS	QUICKSHIP 10 JOURS - MAXIMUM 20 UNITÉS
MODEL MODÈLE		
4269-10	BLOOM 10"	
4269-15	BLOOM 15"	
LIGHT SOURCE SOURCE LUMINEUSE		
LED	REGULAR OUTPUT	LED
COLOR TEMPERATURE TEMPÉRATURE DE COULEUR		
30	3000K	
35	3500K	
40	4000K	
COLOR RENDERING INDEX (CRI) INDICE DE RENDU DE COULEUR (IRC)		
80	80+ CRI	80
VOLTAGE VOLTAGE		
120V	120 VOLT	
277V	277 VOLT	
DIMMING OPTION OPTION DE GRADATION		
DV	0-10V DIMMING (120V-277V)	
DP	PHASE DIMMING (120V ONLY)	
	LED DIMMING DRIVER IS STANDARD IN THIS PRODUCT. PLEASE SPECIFY YOUR DIMMING TYPE.	
CABLE CÂBLE		
C	BLACK CABLE, FIELD ADJUSTABLE	C
CABLE LENGTH LONGUEUR DE CÂBLE		
60	60" CABLE (STD LENGTH)	
**	CUSTOM CABLE LENGTH (PLEASE SPECIFY)	
	FOR OVERALL LENGTH, PLEASE CONTACT YOUR EUREKA REPRESENTATIVE.	
CANOPY FINISH FINI PAVILLON		
BLKE	BLACK FINE TEXTURE	
WHE	WHITE FINE TEXTURE	
SHADE FINISH FINI ABAT-JOUR (A) (B)		
BLKE	BLACK FINE TEXTURE	
WHE	WHITE FINE TEXTURE	
	^(A) SHADE INTERIOR IS ALWAYS WHITE	
	^(B) HEATSINK IS ALWAYS BLACK	
DIFFUSER FINISH FINI DIFFUSEUR		
WH	WHITE	WH

PRODUCT CHARACTERISTICS CARACTÉRISTIQUES DU PRODUIT

BIM **DIM** **EMB** **IES** **LED**

DESIGN: Bloom is a light fixture with a soft and inviting shape. Under the colorful shade hides a luminous globe offering a generous amount of soft light. Bloom is available in two sizes and a variety of different finishes.

INSTALLATION: Easy to install and adjust single power cable mounting.

LIGHT SOURCE: A central powerful COB type light source project a powerful light, softened by the spherical polymer diffuser to create a light that is efficient, yet soft to the eye. Offered with phase or 0-10V gradation options.

STRUCTURE: High-performance die-cast aluminum heatsink with textured black finish. Spun aluminum shades, offered in a wide variety of external finishes with a white internal finish for optimal light reflection.

CERTIFIED: c-CSA-us, c-UL-us

QUICKSHIP

QUICKSHIP

BLOOM 4769

QUICKSHIP
PROJECT PROJET
SPEC TYPE
NOTES



FINISH FINI



BLKE WHE

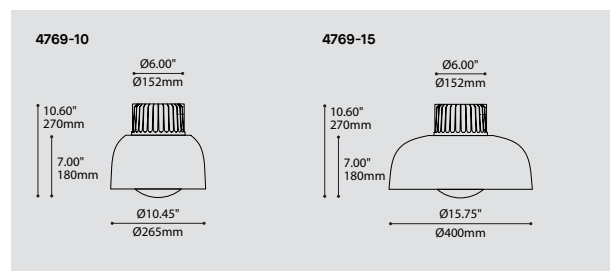

ORDERING SPECIFICATION	SPÉCIFICATION DE COMMANDE	CODE
QUICKSHIP		
QS5	QUICKSHIP 5 DAYS - MAXIMUM 5 UNITS	QUICKSHIP 5 JOURS - MAXIMUM 5 UNITÉS
QS10	QUICKSHIP 10 DAYS - MAXIMUM 20 UNITS	QUICKSHIP 10 JOURS - MAXIMUM 20 UNITÉS
MODEL MODÈLE		
4769-10	BLOOM 10"	
4769-15	BLOOM 15"	
LIGHT SOURCE SOURCE LUMINEUSE		
LED	REGULAR OUTPUT	LED
COLOR TEMPERATURE TEMPÉRATURE DE COULEUR		
30	3000K	
35	3500K	
40	4000K	
COLOR RENDERING INDEX (CRI) INDICE DE RENDU DE COULEUR (IRC)		
80	80+ CRI	80
VOLTAGE VOLTAGE		
120V	120 VOLT	
277V	277 VOLT	
DIMMING OPTION OPTION DE GRADATION		
DV	0-10V DIMMING (120V-277V)	
DP	PHASE DIMMING (120V ONLY)	
	LED DIMMING DRIVER IS STANDARD IN THIS PRODUCT, PLEASE SPECIFY YOUR DIMMING TYPE.	
HEATSINK FINISH FINI RADIATEUR		
BLKE	BLACK FINE TEXTURE	BLKE
SHADE FINISH FINI ABAT-JOUR^(A)		
BLKE	BLACK FINE TEXTURE	
WHE	WHITE FINE TEXTURE	
	^(A) SHADE INTERIOR IS ALWAYS WHITE	
DIFFUSER FINISH FINI DIFFUSEUR		
WH	WHITE	WH
ACCESSORY ACCESSOIRE		
3983	DEEP JUNCTION BOX	3983

ADDITIONAL OPTIONS AVAILABLE ON STANDARD SHIPPING / OPTIONS ADDITIONNELLES DISPONIBLES EN LIVRAISON STANDARD

PRODUCT CHARACTERISTICS CARACTÉRISTIQUES DU PRODUIT

BIM **DIM** **EMB** **IES** **LED**

DESIGN: Bloom is a light fixture with a soft and inviting shape. Under the colorful shade hides a luminous globe offering a generous amount of soft light. Bloom is available in two sizes and a variety of different finishes.

INSTALLATION: Ceiling installation on deep junction box (supplied with light fixture).

LIGHT SOURCE: A central powerful COB type light source project a powerful light, softened by the spherical polymer diffuser to create a light that is efficient, yet soft to the eye. Offered with phase or 0-10V gradation options.

STRUCTURE: High-performance die-cast aluminum heatsink with textured black finish. Spun aluminum shades, offered in a wide variety of external finishes with a white internal finish for optimal light reflection.

CERTIFIED: c-CSA-us, c-UL-us

BLOOM 1209

QUICKSHIP
PROJECT PROJET
SPEC TYPE
NOTES



FINISH FINI



BLKE WHE

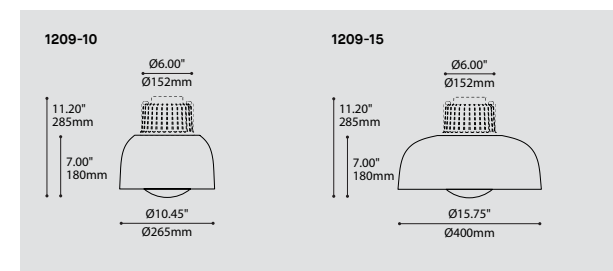

ORDERING SPECIFICATION	SPÉCIFICATION DE COMMANDE	CODE
QUICKSHIP		
QS5	QUICKSHIP 5 DAYS - MAXIMUM 5 UNITS	QUICKSHIP 5 JOURS - MAXIMUM 5 UNITÉS
QS10	QUICKSHIP 10 DAYS - MAXIMUM 20 UNITS	QUICKSHIP 10 JOURS - MAXIMUM 20 UNITÉS
MODEL MODÈLE		
1209-10	BLOOM 10"	
1209-15	BLOOM 15"	
LIGHT SOURCE SOURCE LUMINEUSE		
LED	REGULAR OUTPUT	LED
COLOR TEMPERATURE TEMPÉRATURE DE COULEUR		
30	3000K	
35	3500K	
40	4000K	
COLOR RENDERING INDEX (CRI) INDICE DE RENDU DE COULEUR (IRC)		
80	80+ CRI	80
VOLTAGE VOLTAGE		
120V	120 VOLT	
277V	277 VOLT	
DIMMING OPTION OPTION DE GRADATION		
DV	0-10V DIMMING (120V-277V)	
DP	PHASE DIMMING (120V ONLY)	
	LED DIMMING DRIVER IS STANDARD IN THIS PRODUCT, PLEASE SPECIFY YOUR DIMMING TYPE.	
SHADE FINISH FINI ABAT-JOUR^(A)		
BLKE	BLACK FINE TEXTURE	
WHE	WHITE FINE TEXTURE	
	^(A) SHADE INTERIOR IS ALWAYS WHITE	
DIFFUSER FINISH FINI DIFFUSEUR		
WH	WHITE	WH

ADDITIONAL OPTIONS AVAILABLE ON STANDARD SHIPPING / OPTIONS ADDITIONNELLES DISPONIBLES EN LIVRAISON STANDARD

PRODUCT CHARACTERISTICS CARACTÉRISTIQUES DU PRODUIT

BIM **DIM** **EMB** **IES** **LED** 
e 6.00" (152mm)

DESIGN: Bloom is a light fixture with a soft and inviting shape. Under the colorful shade hides a luminous globe offering a generous amount of soft light. Bloom is available in two sizes and a variety of different finishes.

INSTALLATION: Recessed mounting system allows for simple and secure installation in a variety of ceiling types from 0.375" (9.5mm) to 2.75" (70mm) thick, accommodating renovation projects.

LIGHT SOURCE: A central powerful COB type light source project a powerful light, softened by the spherical polymer diffuser to create a light that is efficient, yet soft to the eye. Offered with phase or 0-10V gradation options.

STRUCTURE: High-performance die-cast aluminum heatsink with textured black finish. Spun aluminum shades, offered in a wide variety of external finishes with a white internal finish for optimal light reflection.

CERTIFIED: c-CSA-us

MIKA 4230

QUICKSHIP

PROJECT PROJET

SPEC TYPE

NOTES



OPTIONS



4230-8

4230-12

4230-16

FAMILY FAMILLE



4428-16-RAP

4428-10-RAP

3230-12

MOUNTING OPTIONS OPTIONS DE MONTAGE

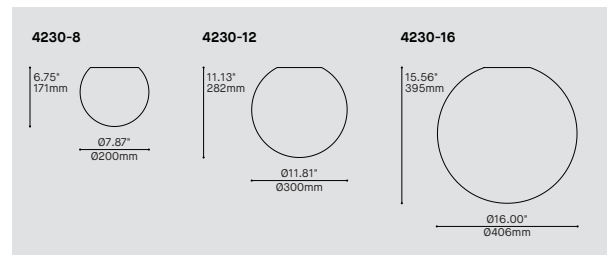
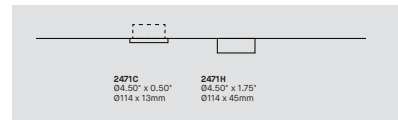

ORDERING SPECIFICATION SPÉCIFICATION DE COMMANDE

CODE

QUICKSHIP

QS5 QUICKSHIP 5 DAYS - MAXIMUM 5 UNITS QUICKSHIP 5 JOURS - MAXIMUM 5 UNITÉS
QS10 QUICKSHIP 10 DAYS - MAXIMUM 20 UNITS QUICKSHIP 10 JOURS - MAXIMUM 20 UNITÉS

MODEL MODÈLE

4230-8 MIKA 8"
4230-12 MIKA 12"
4230-16 MIKA 16"

LIGHT SOURCE SOURCE LUMINEUSE

LED

LED REGULAR OUTPUT

COLOR TEMPERATURE TEMPÉRATURE DE COULEUR (A)

30 3000K
35 3500K
40 4000K

COLOR RENDERING INDEX (CRI) INDICE DE RENDU DE COULEUR (IRC)

80

80 80+ CRI

VOLTAGE VOLTAGE

120V 120 VOLT
277V 277 VOLT

CONTROL OPTION OPTION DE CONTRÔLE

DV 0-10V DIMMING (120V-277V)
DP PHASE DIMMING (120V ONLY)
NLTAIR2* NLIGHT AIR CONTROL GEN 2
NLIGHT* NLIGHT WIRED CONTROL
*REQUIRES RC3 CANOPY. REFER TO NLIGHT GUIDE AND INSTALLATION SHEET FOR ALL REQUIREMENTS.

CABLE CÂBLE

C

C CLEAR CABLE, FIELD ADJUSTABLE

CABLE LENGTH LONGUEUR DE CÂBLE

60 60" CABLE (STD LENGTH)
** CUSTOM CABLE LENGTH (PLEASE SPECIFY)
FOR OVERALL LENGTH, PLEASE CONTACT YOUR EUREKA REPRESENTATIVE

MOUNTING MONTAGE

RC1 ROUND CANOPY / PAVILLON ROND
FOR DIMMING LED: 1.75" CANOPY (2471H)
RC2* FOR DIMMING LED: 0.5" CANOPY (2471C)
RC3 NLIGHT SCREWLESS 1.75" CANOPY (2474H)
*3983 ACCESSORY PROVIDED

CANOPY FINISH FINI PAVILLON

WHE

WHE WHITE FINE TEXTURE

DIFFUSER FINISH FINI DIFFUSEUR

WH

WH WHITE

ACCESSORY ACCESSOIRE

3983* DEEP JUNCTION BOX (PROVIDED FOR SCREWLESS 0.5" CANOPY 2471C)
*JUNCTION BOX IS AVAILABLE FOR ADVANCE SHIPPING

ADDITIONAL OPTIONS AVAILABLE ON STANDARD SHIPPING / OPTIONS ADDITIONNELLES DISPONIBLES EN LIVRAISON STANDARD

PRODUCT CHARACTERISTICS CARACTÉRISTIQUES DU PRODUIT



DESIGN: Classic round globe with an evenly frosted shade available with 8", 12" and 16" diameters. Mika can be specified as a ceiling or wall mount and pendant. Suspension on clear power cable, easy to install and adjust on site. Two magnetic canopies with no visible fastener are available: standard (2471H) or slim (2471C) provided with a deep junction box (3983).

INSTALLATION: High performance LED module mounted on an extruded aluminum heatsink, Mika is offered with standard dimming options 0-10V (DV) or phase (DP). Emergency options available.

LIGHT SOURCE: Translucent white diffuser made of impact resistant rotomolded MDPE.

DIFFUSER: c-CSA-us

CERTIFIED: c-CSA-us

MIKA 3230

QUICKSHIP

PROJECT PROJET

SPEC TYPE

NOTES



OPTIONS



3230-8

3230-12

3230-16

FAMILY FAMILLE



4428-16-RAP

4428-10-RAP

4230-12

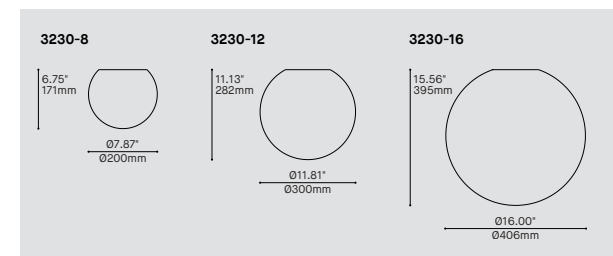

ORDERING SPECIFICATION SPÉCIFICATION DE COMMANDE

CODE

QUICKSHIP

QS5 QUICKSHIP 5 DAYS - MAXIMUM 5 UNITS QUICKSHIP 5 JOURS - MAXIMUM 5 UNITÉS
QS10 QUICKSHIP 10 DAYS - MAXIMUM 20 UNITS QUICKSHIP 10 JOURS - MAXIMUM 20 UNITÉS

MODEL MODÈLE

3230-8 MIKA 8"
3230-12 MIKA 12"
3230-16 MIKA 16"

LIGHT SOURCE SOURCE LUMINEUSE

LED

LED REGULAR OUTPUT

COLOR TEMPERATURE TEMPÉRATURE DE COULEUR (A)

30 3000K
35 3500K
40 4000K

COLOR RENDERING INDEX (CRI) INDICE DE RENDU DE COULEUR (IRC)

80

80 80+ CRI

VOLTAGE VOLTAGE

120V 120 VOLT
277V 277 VOLT

CONTROL OPTION OPTION DE CONTRÔLE

DV 0-10V DIMMING (120V-277V)
DP PHASE DIMMING (120V ONLY)
NLTAIR2* NLIGHT AIR CONTROL GEN 2
NLIGHT* NLIGHT WIRED CONTROL
*NLIGHT INTEGRATION REQUIRES THE USAGE OF A REMOTE BOX. REFER TO NLIGHT GUIDE AND INSTALLATION SHEET FOR ALL REQUIREMENTS.

DIFFUSER FINISH FINI DIFFUSEUR

WH

WH WHITE

ACCESSORY ACCESSOIRE

3983* DEEP JUNCTION BOX (PROVIDED DV AND DP)
*JUNCTION BOX IS AVAILABLE FOR ADVANCE SHIPPING

ADDITIONAL OPTIONS AVAILABLE ON STANDARD SHIPPING / OPTIONS ADDITIONNELLES DISPONIBLES EN LIVRAISON STANDARD

PRODUCT CHARACTERISTICS CARACTÉRISTIQUES DU PRODUIT



DESIGN: Classic round globe with an evenly frosted shade available with 8", 12" and 16" diameters. Mika can be specified as a ceiling or wall mount and pendant.

INSTALLATION: Designed with a "twist and lock" installation system for easy installation without visible fasteners. Mika is mounted on a deep junction box (3983 - included).

LIGHT SOURCE: High performance LED module mounted on an extruded aluminum heatsink, Mika is offered with standard dimming options 0-10V (DV) or phase (DP). Emergency and nLight options available.

DIFFUSER: Translucent white diffuser made of impact resistant rotomolded MDPE.

CERTIFIED: c-CSA-us

MOONRISE CLASSIC 3530-23

QUICKSHIP
PROJECT PROJET
SPEC TYPE
NOTES

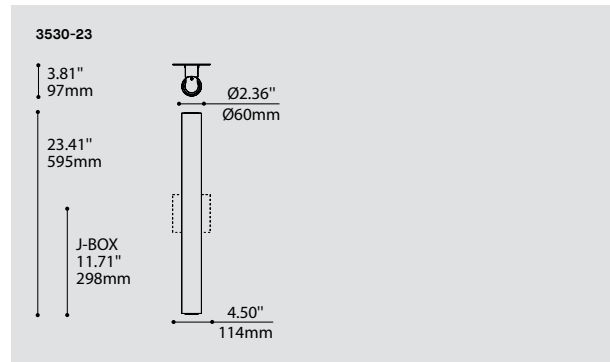
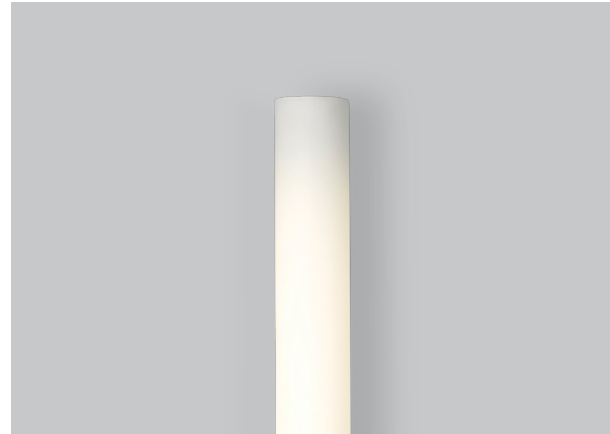

ORDERING SPECIFICATION	SPÉCIFICATION DE COMMANDE	CODE
QUICKSHIP		
QS5	QUICKSHIP 5 DAYS - MAXIMUM 5 UNITS QUICKSHIP 5 JOURS - MAXIMUM 5 UNITÉS	
QS10	QUICKSHIP 10 DAYS - MAXIMUM 20 UNITS QUICKSHIP 10 JOURS - MAXIMUM 20 UNITÉS	
MODEL MODÈLE		3530-23
3530-23	MOONRISE CLASSIC 23" (ROUND GLASS)	
LIGHT SOURCE SOURCE LUMINEUSE		
LED	REGULAR OUTPUT	
LED.HO	HIGH OUTPUT	
COLOR TEMPERATURE TEMPÉRATURE DE COULEUR (K)		
30	3000K	
35	3500K	
40	4000K	
VOLTAGE VOLTAGE		
120V	120 VOLT	
277V	277 VOLT	
DIMMING OPTION OPTION DE GRADATION		
DV	0-10V DIMMING (120V-277V)	
STRUCTURE FINISH FINI STRUCTURE		
CHR	CHROME	
S C	SATIN CHROME	
DIFFUSER FINISH FINI DIFFUSEUR		WH
WH	WHITE	
ACCESSORY ACCESSOIRE		
3980	MINI JUNCTION BOX	
ADDITIONAL OPTIONS AVAILABLE ON STANDARD SHIPPING / OPTIONS ADDITIONNELLES DISPONIBLES EN LIVRAISON STANDARD		

PRODUCT CHARACTERISTICS CARACTÉRISTIQUES DU PRODUIT



DESIGN: Modern classic round profile wall sconce or surface mounted fixture. ADA compliant.
STRUCTURE: Machined steel end caps & die-stamped steel structure with plated finish.
DIFFUSER: Hand blown white triplex glass.
CERTIFIED: c-CSA-us, c-UL-us

CONCEPTION: Applique ou plafonnier cylindrique classique et contemporain. Conforme à la norme ADA.
STRUCTURE: Embout d'acier usiné et acier embouti plaqués.
ABAT-JOUR: Verre triplex blanc soufflé à la main.
CERTIFIÉ: c-CSA-us, c-UL-us

MUTE 4258-16

QUICKSHIP
PROJECT PROJET
SPEC TYPE
NOTES



FINISH FINI

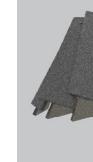

CHF

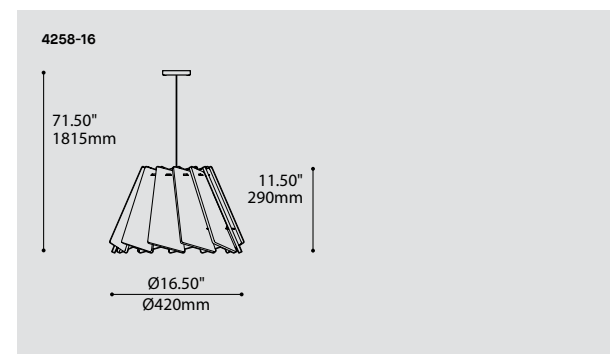

ORDERING SPECIFICATION	SPÉCIFICATION DE COMMANDE	CODE
QUICKSHIP		
QS5	QUICKSHIP 5 DAYS - MAXIMUM 5 UNITS QUICKSHIP 5 JOURS - MAXIMUM 5 UNITÉS	
QS10	QUICKSHIP 10 DAYS - MAXIMUM 20 UNITS QUICKSHIP 10 JOURS - MAXIMUM 20 UNITÉS	
MODEL MODÈLE		4258-16
4258-16	MUTE 16"	
LIGHT SOURCE SOURCE LUMINEUSE		LED
LED	REGULAR OUTPUT	
COLOR TEMPERATURE TEMPÉRATURE DE COULEUR		
30	3000K	
35	3500K	
40	4000K	
COLOR RENDERING INDEX (CRI) INDICE DE RENDU DE COULEUR (IRC)		80
80	80+ CRI	
VOLTAGE VOLTAGE		
120V	120 VOLT	
277V	277 VOLT	
CONTROL OPTION OPTION DE CONTRÔLE		
DV	0-10V DIMMING (120V-277V)	
DP	PHASE DIMMING (120V ONLY)	
	LED DIMMING DRIVER IS STANDARD IN THIS PRODUCT. PLEASE SPECIFY YOUR DIMMING TYPE	
CABLE CÂBLE		C
C	CLEAR CABLE, FIELD ADJUSTABLE	
MOUNTING MONTAGE		
RC2*	ROUND CANOPY/PAVILLON ROND SCREWLESS 0.5" CANOPY (2471C) *3983 ACCESSORY PROVIDED FOR 2471C CANOPY	
CABLE LENGTH LONGUEUR DE CÂBLE		
60	60" CABLE (STD LENGTH)	
**	CUSTOM CABLE LENGTH (PLEASE SPECIFY) FOR OVERALL LENGTH, PLEASE CONTACT YOUR EUREKA REPRESENTATIVE	
CANOPY FINISH FINI PAVILLON		WHE
WHE	WHITE FINE TEXTURE	
SHADE FINISH FINI ABAT-JOUR		CHF
CHF	CHARCOAL FELT	
ACRYLIC FINISH FINI ACRYLIQUE		WH
WH	WHITE	
ACCESSORY ACCESSOIRE		
3983*	DEEP JUNCTION BOX (PROVIDED FOR 2471C CANOPY) *JUNCTION BOX IS AVAILABLE FOR ADVANCE SHIPPING	

PRODUCT CHARACTERISTICS CARACTÉRISTIQUES DU PRODUIT



DESIGN: Now offered in two formats, this soft, colorful and sound absorbing large format downlight pendant is composed of twelve felt-like acoustic panels surrounding a custom LED light source distributing a uniform and direct light.

INSTALLATION: Easy to install, adjust single power cable mounting with clip-on acoustic panels.

LIGHT SOURCE: Mute features a custom LED light engine supplied with a standard dimming driver (0-10V or phase).

STRUCTURE: Precision cut chrome top cover plate and white or chrome canopy.

SHADE: The custom CNC cut panels are made from recycled PET bottles and are recyclable. Available in charcoal.

CERTIFIED: c-CSA-us

MUTE 4258-32

QUICKSHIP

PROJECT PROJET

SPEC TYPE

NOTES



FINISH FINI

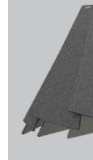

CHF

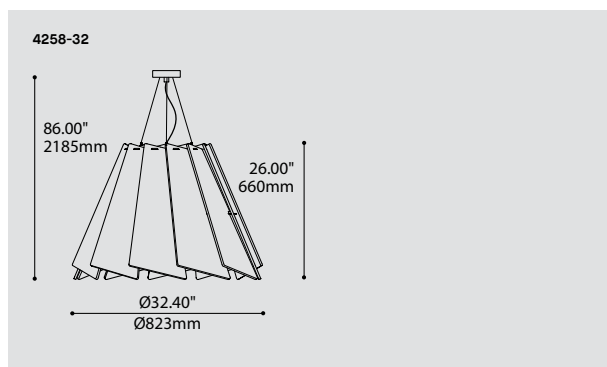

ORDERING SPECIFICATION SPÉCIFICATION DE COMMANDE

CODE

QUICKSHIP

QS5 QUICKSHIP 5 DAYS - MAXIMUM 5 UNITS QUICKSHIP 5 JOURS - MAXIMUM 5 UNITÉS
 QS10 QUICKSHIP 10 DAYS - MAXIMUM 20 UNITS QUICKSHIP 10 JOURS - MAXIMUM 20 UNITÉS

MODEL MODÈLE 4258-32 MUTE 32"

LIGHT SOURCE SOURCE LUMINEUSE LED

LED REGULAR OUTPUT

COLOR TEMPERATURE TEMPÉRATURE DE COULEUR

30 3000K

35 3500K

40 4000K

COLOR RENDERING INDEX (CRI) INDICE DE RENDU DE COULEUR (IRC) 80

80 80+ CRI

VOLTAGE VOLTAGE

120V 120 VOLT

277V 277 VOLT

CONTROL OPTION OPTION DE CONTRÔLE

DV 0-10V DIMMING (120V-277V)

DP PHASE DIMMING (120V ONLY)

LED DIMMING DRIVER IS STANDARD IN THIS PRODUCT, PLEASE SPECIFY YOUR DIMMING TYPE

CABLE CÂBLE AC

AC AIRCRAFT MOUNTING & CLEAR CABLE, FIELD ADJUSTABLE

CABLE LENGTH LONGUEUR DE CÂBLE

60 60" AIRCRAFT CABLE (STD LENGTH)

** CUSTOM AIRCRAFT CABLE LENGTH (PLEASE SPECIFY)

FOR OVERALL LENGTH, PLEASE CONTACT YOUR EUREKA REPRESENTATIVE

MOUNTING MONTAGE

RC2* ROUND CANOPY/PAVILLON ROND

SCREWLESS 0.5" CANOPY (2471C)

*3983 ACCESSORY PROVIDED FOR 2471C CANOPY

CANOPY FINISH FINI PAVILLON WHE

WHE WHITE FINE TEXTURE

SHADE FINISH FINI ABAT-JOUR CHF

CHF CHARCOAL FELT

ACRYLIC FINISH FINI ACRYLIQUE WH

WH WHITE

ACCESSORY ACCESSOIRE

3983* DEEP JUNCTION BOX (PROVIDED FOR 2471C CANOPY)

*JUNCTION BOX IS AVAILABLE FOR ADVANCE SHIPPING

PRODUCT CHARACTERISTICS CARACTÉRISTIQUES DU PRODUIT

BIM **DIM** **IES** **LED** **)))**

- DESIGN:** Now offered in two formats, this soft, colorful and sound absorbing large format downlight pendant is composed of twelve felt-like acoustic panels surrounding a custom LED light source distributing a uniform and direct light.
- INSTALLATION:** Easy to install, adjust and level triple aircraft cable mounting with clip-on acoustic panels.
- LIGHT SOURCE:** Mute features a custom LED light engine supplied with a standard dimming driver (0-10V or phase).
- STRUCTURE:** Precision cut chrome top cover plate and white or chrome canopy.
- SHADE:** The custom CNC cut panels are made from recycled PET bottles and are recyclable. Available in charcoal.
- CERTIFIED:** c-CSA-us

Confidential Client
 Québec City, Québec, CA

Photo Credit: Stephane Groleau



SCOUT 4048

QUICKSHIP

PROJECT PROJET

SPEC TYPE

NOTES



FINISH FINI



BLKE WHE

OVERALL HEIGHT HAUTEUR HORS TOUT

	LED 0.50" CANOPY
MOUNTING	2471C
CABLE & 4048-6	69.70"
CABLE & 4048-10	73.95"
CABLE & 4048-18	81.45"

MOUNTING OPTIONS OPTIONS DE MONTAGE



STEM OR CABLE OPTION OPTIONS DE TIGE OU CABLE

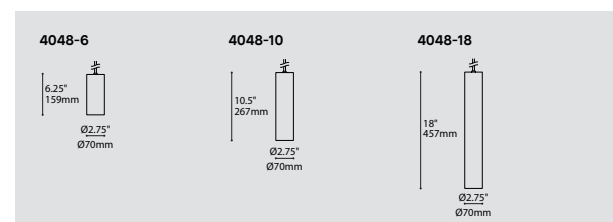
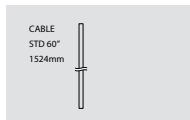

ORDERING SPECIFICATION SPÉCIFICATION DE COMMANDE

CODE

QUICKSHIP

QS5 QUICKSHIP 5 DAYS - MAXIMUM 5 UNITS QUICKSHIP 5 JOURS - MAXIMUM 5 UNITÉS
QS10 QUICKSHIP 10 DAYS - MAXIMUM 20 UNITS QUICKSHIP 10 JOURS - MAXIMUM 20 UNITÉS

MODEL MODÈLE

4048-6 SCOUT 6"
4048-10 SCOUT 10"
4048-18 SCOUT 18"

LIGHT SOURCE SOURCE LUMINEUSE

LED REGULAR OUTPUT
LED.HO HIGH OUTPUT

COLOR TEMPERATURE TEMPÉRATURE DE COULEUR

30 3000K
35 3500K
40 4000K

COLOR RENDERING INDEX (CRI) INDICE DE RENDU DE COULEUR (IRC)

80 80+ CRI

VOLTAGE VOLTAGE

120V 120 VOLT
277V 277 VOLT

DIMMING OPTION OPTION DE GRADATION

DV 0-10V DIMMING (120V-277V)
DP PHASE DIMMING (120V ONLY)
LED DIMMING DRIVER IS STANDARD IN THIS PRODUCT, PLEASE SPECIFY YOUR DIMMING TYPE

BEAM ANGLE ANGLE DE FAISCEAU

NA NARROW (24°)
ME MEDIUM (48°)

OPTICAL ACCESSORIES ACCESSOIRES OPTIQUES

CLR CLEAR GLASS LENS
FRO FROSTED GLASS LENS
HON HONEYCOMB LOUVER
SOL SOLITE SOFTENING LENS

CABLE CABLE

C* BLACK OR WHITE CABLE, FIELD ADJUSTABLE
*FOR WHITE STRUCTURE: WHITE CABLE, FOR OTHER STRUCTURE FINISH: BLACK CABLE

CABLE LENGTH LONGUEUR DE CABLE

60 60" CABLE (STD LENGTH)
** CUSTOM CABLE LENGTH (PLEASE SPECIFY)
FOR OVERALL LENGTH, PLEASE CONTACT YOUR EUREKA REPRESENTATIVE

MOUNTING MONTAGE

RC ROUND CANOPY / PAVILLON ROND
SCREWLESS 0.5" CANOPY (2471C)

CANOPY FINISH FINI PAVILLON

BLKE BLACK FINE TEXTURE
WHE WHITE FINE TEXTURE

STRUCTURE FINISH FINI STRUCTURE

BLKE BLACK FINE TEXTURE
WHE WHITE FINE TEXTURE

BAFFLE FINISH FINI DÉFLECTEUR

BLKE BLACK FINE TEXTURE
WHE WHITE FINE TEXTURE

ACCESSORY ACCESSOIRE

3983 DEEP JUNCTION BOX (PROVIDED FOR 4048-6 WITH CANOPY)

ADDITIONAL OPTIONS AVAILABLE ON STANDARD SHIPPING / OPTIONS ADDITIONNELLES DISPONIBLES EN LIVRAISON STANDARD

SCOUT 4049

QUICKSHIP

PROJECT PROJET

SPEC TYPE

NOTES



FINISH FINI



BLKE WHE

OVERALL HEIGHT HAUTEUR HORS TOUT

	LED 0.50" CANOPY
MOUNTING	2471C
CABLE & 4049-6	69.70"
CABLE & 4049-10	73.95"
CABLE & 4049-18	81.45"

MOUNTING OPTIONS OPTIONS DE MONTAGE

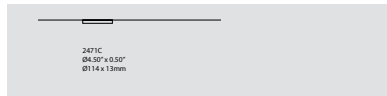

STEM OR CABLE OPTION OPTIONS DE TIGE OU CABLE

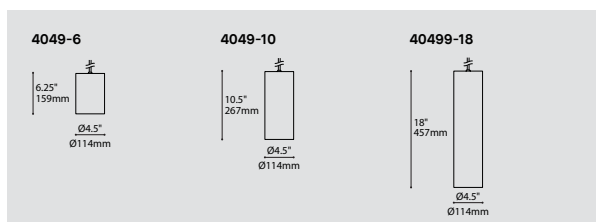
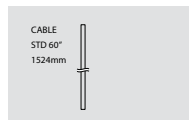

ORDERING SPECIFICATION SPÉCIFICATION DE COMMANDE

CODE

QUICKSHIP

QS5 QUICKSHIP 5 DAYS - MAXIMUM 5 UNITS QUICKSHIP 5 JOURS - MAXIMUM 5 UNITÉS
QS10 QUICKSHIP 10 DAYS - MAXIMUM 20 UNITS QUICKSHIP 10 JOURS - MAXIMUM 20 UNITÉS

MODEL MODÈLE

4049-6 SCOUT 6"
4049-10 SCOUT 10"
4049-18 SCOUT 18"

LIGHT SOURCE SOURCE LUMINEUSE

LED REGULAR OUTPUT
LED.HO HIGH OUTPUT

COLOR TEMPERATURE TEMPÉRATURE DE COULEUR

30 3000K
35 3500K
40 4000K

COLOR RENDERING INDEX (CRI) INDICE DE RENDU DE COULEUR (IRC)

80 80+ CRI

VOLTAGE VOLTAGE

120V 120 VOLT
277V 277 VOLT

DIMMING OPTION OPTION DE GRADATION

DV 0-10V DIMMING (120V-277V)
DP PHASE DIMMING (120V ONLY)
LED DIMMING DRIVER IS STANDARD IN THIS PRODUCT, PLEASE SPECIFY YOUR DIMMING TYPE

BEAM ANGLE ANGLE DE FAISCEAU

NA NARROW (28°)
ME MEDIUM (48°)
WI WIDE (64°)

OPTICAL ACCESSORIES ACCESSOIRES OPTIQUES

CLR CLEAR GLASS LENS
FRO FROSTED GLASS LENS
HON HONEYCOMB LOUVER
SOL SOLITE SOFTENING LENS

CABLE CABLE

C* BLACK OR WHITE CABLE, FIELD ADJUSTABLE
*FOR WHITE STRUCTURE: WHITE CABLE, FOR OTHER STRUCTURE FINISH: BLACK CABLE

CABLE LENGTH LONGUEUR DE CABLE

60 60" CABLE (STD LENGTH)
** CUSTOM CABLE LENGTH (PLEASE SPECIFY)
FOR OVERALL LENGTH, PLEASE CONTACT YOUR EUREKA REPRESENTATIVE

MOUNTING MONTAGE

RC ROUND CANOPY / PAVILLON ROND
SCREWLESS 0.5" CANOPY (2471C)

CANOPY FINISH FINI PAVILLON

BLKE BLACK FINE TEXTURE
WHE WHITE FINE TEXTURE

STRUCTURE FINISH FINI STRUCTURE

BLKE BLACK FINE TEXTURE
WHE WHITE FINE TEXTURE

BAFFLE FINISH FINI DÉFLECTEUR

BLKE BLACK FINE TEXTURE
WHE WHITE FINE TEXTURE

ACCESSORY ACCESSOIRE

3983 DEEP JUNCTION BOX (PROVIDED FOR 4049-6 WITH CANOPY)

ADDITIONAL OPTIONS AVAILABLE ON STANDARD SHIPPING / OPTIONS ADDITIONNELLES DISPONIBLES EN LIVRAISON STANDARD

QUICKSHIP

QUICKSHIP

SCOUT 4548

QUICKSHIP
PROJECT PROJÉT
SPEC TYPE
NOTES



FINISH FINI



BLKE WHE RDP

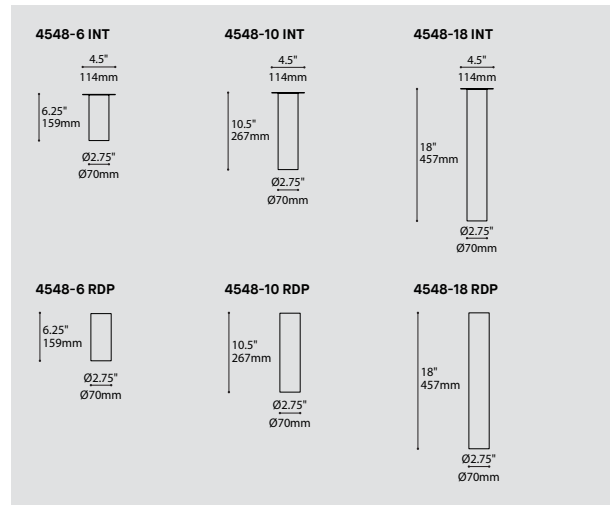

ORDERING SPECIFICATION	SPÉCIFICATION DE COMMANDE	CODE
QUICKSHIP		
QS5	QUICKSHIP 5 DAYS - MAXIMUM 5 UNITS QUICKSHIP 5 JOURS - MAXIMUM 5 UNITÉS	
QS10	QUICKSHIP 10 DAYS - MAXIMUM 20 UNITS QUICKSHIP 10 JOURS - MAXIMUM 20 UNITÉS	
MODEL MODÈLE		
4548-6	SCOUT 6"	
4548-10	SCOUT 10"	
4548-18	SCOUT 18"	
LIGHT SOURCE SOURCE LUMINEUSE		
LED	REGULAR OUTPUT	
LED.HO	HIGH OUTPUT	
COLOR TEMPERATURE TEMPÉRATURE DE COULEUR		
30	3000K	
35	3500K	
40	4000K	
COLOR RENDERING INDEX (CRI) INDICE DE RENDU DE COULEUR (IRC)		80
80	80+ CRI	
VOLTAGE VOLTAGE		
120V	120 VOLT	
277V	277 VOLT	
DIMMING OPTION OPTION DE GRADATION		
DV	0-10V DIMMING (120V-277V)	
DP	PHASE DIMMING (120V ONLY)	
	LED DIMMING DRIVER IS STANDARD IN THIS PRODUCT, PLEASE SPECIFY YOUR DIMMING TYPE	
BEAM ANGLE ANGLE DE FAISCEAU		
NA	NARROW (24°)	
ME	MEDIUM (45°)	
OPTICAL ACCESSORIES ACCESSOIRES OPTIQUES		
CLR	CLEAR GLASS LENS	
FRO	FROSTED GLASS LENS	
HON	HONEYCOMB LOUVER	
SOL	SOLITE SOFTENING LENS	
DRIVER & CANOPY OPTION OPTION DE PILOTE & PAVILLON		
INT*	INTERNAL DRIVER, WITH FLAT CANOPY	
RDP	RECESSED DRIVER, NO CANOPY	
	*FOR 4548-6, DRIVER WILL BE IN DEEP JUNCTION BOX	
CANOPY FINISH FINI PAVILLON ^(A)		
WHE*	WHITE FINE TEXTURE	
	^(A) IF NO FINISH IS SELECTED, FLAT CANOPY FINISH WILL BE THE SAME AS STRUCTURE FINISH	
	^(B) FILL IN IF INT DRIVER & CANOPY OPTION AND WHE FINISH IS SELECTED, OTHERWISE LEAVE EMPTY	
STRUCTURE FINISH FINI STRUCTURE		
BLKE	BLACK FINE TEXTURE	
WHE	WHITE FINE TEXTURE	
BAFFLE FINISH FINI DÉFLECTEUR		
BLKE	BLACK FINE TEXTURE	
WHE	WHITE FINE TEXTURE	
ACCESSORY ACCESSOIRE		
3983	DEEP JUNCTION BOX (PROVIDED FOR 4548-6 WITH INT OPTION)	

ADDITIONAL OPTIONS AVAILABLE ON STANDARD SHIPPING / OPTIONS ADDITIONNELLES DISPONIBLES EN LIVRAISON STANDARD

PRODUCT CHARACTERISTICS CARACTÉRISTIQUES DU PRODUIT



CERTIFIED: c-CSA-us

SCOUT 4549

QUICKSHIP
PROJECT PROJÉT
SPEC TYPE
NOTES



FINISH FINI



BLKE WHE

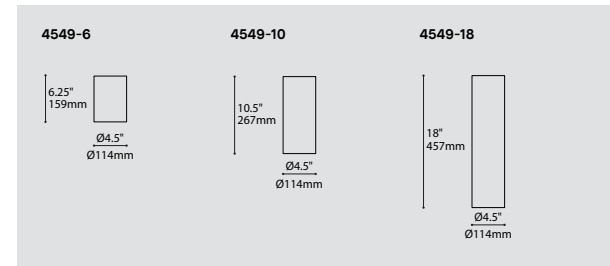

ORDERING SPECIFICATION	SPÉCIFICATION DE COMMANDE	CODE
QUICKSHIP		
QS5	QUICKSHIP 5 DAYS - MAXIMUM 5 UNITS QUICKSHIP 5 JOURS - MAXIMUM 5 UNITÉS	
QS10	QUICKSHIP 10 DAYS - MAXIMUM 20 UNITS QUICKSHIP 10 JOURS - MAXIMUM 20 UNITÉS	
MODEL MODÈLE		
4549-6	SCOUT 6"	
4549-10	SCOUT 10"	
4549-18	SCOUT 18"	
LIGHT SOURCE SOURCE LUMINEUSE		
LED	REGULAR OUTPUT	
LED.HO	HIGH OUTPUT	
COLOR TEMPERATURE TEMPÉRATURE DE COULEUR		
30	3000K	
35	3500K	
40	4000K	
COLOR RENDERING INDEX (CRI) INDICE DE RENDU DE COULEUR (IRC)		80
80	80+ CRI	
VOLTAGE VOLTAGE		
120V	120 VOLT	
277V	277 VOLT	
DIMMING OPTION OPTION DE GRADATION		
DV	0-10V DIMMING (120V-277V)	
DP	PHASE DIMMING (120V ONLY)	
	LED DIMMING DRIVER IS STANDARD IN THIS PRODUCT, PLEASE SPECIFY YOUR DIMMING TYPE	
BEAM ANGLE ANGLE DE FAISCEAU		
NA	NARROW (28°)	
ME	MEDIUM (48°)	
WI	WIDE (64°)	
OPTICAL ACCESSORIES ACCESSOIRES OPTIQUES		
CLR	CLEAR GLASS LENS	
FRO	FROSTED GLASS LENS	
HON	HONEYCOMB LOUVER	
SOL	SOLITE SOFTENING LENS	
STRUCTURE FINISH FINI STRUCTURE		
BLKE	BLACK FINE TEXTURE	
WHE	WHITE FINE TEXTURE	
BAFFLE FINISH FINI DÉFLECTEUR		
BLKE	BLACK FINE TEXTURE	
WHE	WHITE FINE TEXTURE	
ACCESSORY ACCESSOIRE		
3983	DEEP JUNCTION BOX (PROVIDED FOR 4549-6)	

ADDITIONAL OPTIONS AVAILABLE ON STANDARD SHIPPING / OPTIONS ADDITIONNELLES DISPONIBLES EN LIVRAISON STANDARD

PRODUCT CHARACTERISTICS CARACTÉRISTIQUES DU PRODUIT





STELLA 4272-9

QUICKSHIP

PROJECT PROJET

SPEC TYPE

NOTES



FINISH FINI



BLKE



WHE

4272-9

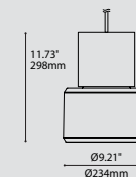

ORDERING SPECIFICATION SPÉCIFICATION DE COMMANDE

CODE

QUICKSHIP

QS5 QUICKSHIP 5 DAYS - MAXIMUM 5 UNITS QUICKSHIP 5 JOURS - MAXIMUM 5 UNITÉS
 QS10 QUICKSHIP 10 DAYS - MAXIMUM 20 UNITS QUICKSHIP 10 JOURS - MAXIMUM 20 UNITÉS

MODEL MODÈLE

4272DI-9 STELLA

4272DI-9

LIGHT SOURCE SOURCE LUMINEUSE

LED REGULAR OUTPUT
 LED.HO HIGH OUTPUT

COLOR TEMPERATURE TEMPÉRATURE DE COULEUR

30 3000K
 35 3500K
 40 4000K

COLOR RENDERING INDEX (CRI) INDICE DE RENDU DE COULEUR (IRC)

80 80+ CRI

80

VOLTAGE VOLTAGE

120V 120 VOLT
 277V 277 VOLT

DIMMING OPTION OPTION DE GRADATION

DV 0-10V DIMMING (120V-277V)
 DP PHASE DIMMING (120V ONLY)
 LED DIMMING DRIVER IS STANDARD IN THIS PRODUCT, PLEASE SPECIFY YOUR DIMMING TYPE.

STEM OR CABLE TIGE OU CABLE

C CABLE, FIELD ADJUSTABLE

C

STEM OR CABLE LENGTH LONGUEUR DE TIGE OU CABLE

60 60" CABLE (STD LENGTH)
 ** CUSTOM CABLE LENGTH (PLEASE SPECIFY)
 FOR OVERALL LENGTH, PLEASE CONTACT YOUR EUREKA REPRESENTATIVE.

CANOPY FINISH FINI PAVILLON

BLKE BLACK FINE TEXTURE
 WHE WHITE FINE TEXTURE

SHADE FINISH FINI ABAT-JOUR (A)^(B)

BLKE BLACK FINE TEXTURE
 WHE WHITE FINE TEXTURE
^(A) SHADE INTERIOR IS ALWAYS WHITE
^(B) SHADE FINISH DICTATES THE CABLE COLOR

DIFFUSER FINISH FINI DIFFUSEUR

WH WHITE

WH

ADDITIONAL OPTIONS AVAILABLE ON STANDARD SHIPPING / OPTIONS ADDITIONNELLES DISPONIBLES EN LIVRAISON STANDARD

PRODUCT CHARACTERISTICS CARACTÉRISTIQUES DU PRODUIT

BIM **DIM** **EMB** **IES** **LED**

DESIGN: Stella, at its core, is a powerful light engine fused to a minimalist aluminum shell. A large diffusion dome hidden inside the shade create a uniform direct & indirect illumination. Also offered in a direct only configuration.

INSTALLATION: Single cable or stem for a minimalist look.

LIGHT SOURCE: A highly powerful COB type light source project a light, softened by a large polymer diffusion dome to create an illumination that is efficient & uniform. Some of the light is reflected upward by the dome; thus illuminating indirectly the ceiling. Many control options available.

SHADE: The precision spun aluminum shade is optimized to reduce glare. White internal finish for optimal light reflection.

CERTIFIED: c-CSA-us

QUICKSHIP

TWIN 4268

QUICKSHIP
PROJECT PROJET
SPEC TYPE
NOTES



FINISH FINI



BLKE WHE

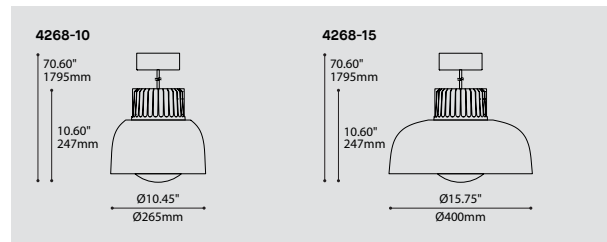

ORDERING SPECIFICATION	SPÉCIFICATION DE COMMANDE	CODE
QUICKSHIP		
QS5	QUICKSHIP 5 DAYS - MAXIMUM 5 UNITS	QUICKSHIP 5 JOURS - MAXIMUM 5 UNITÉS
QS10	QUICKSHIP 10 DAYS - MAXIMUM 20 UNITS	QUICKSHIP 10 JOURS - MAXIMUM 20 UNITÉS
MODEL	MODÈLE	
4268-10	TWIN 10"	
4268-15	TWIN 15"	
4268-10-DD*	TWIN 10" (DUAL DIMMING)	
4268-15-DD*	TWIN 15" (DUAL DIMMING)	
	*INNER AND OUTER LIGHT SOURCES ARE DIMMED INDEPENDANTLY	
LIGHT SOURCE	SOURCE LUMINEUSE	LED
LED	REGULAR OUTPUT	
COLOR TEMPERATURE	TEMPÉRATURE DE COULEUR	
30	3000K	
35	3500K	
40	4000K	
COLOR RENDERING INDEX (CRI)	INDICE DE RENDU DE COULEUR (IRC)	80
80	80+ CRI	
VOLTAGE	VOLTAGE	
120V	120 VOLT	
277V	277 VOLT	
DIMMING OPTION	OPTION DE GRADATION	
DV	0-10V DIMMING (120V-277V)	
DP	PHASE DIMMING (120V ONLY)	
	LED DIMMING DRIVER IS STANDARD IN THIS PRODUCT, PLEASE SPECIFY YOUR DIMMING TYPE.	
BEAM ANGLE	ANGLE DE FAISCEAU	40
40	40° LENS	
CABLE	CABLE	C
C	BLACK CABLE, FIELD ADJUSTABLE	
CABLE LENGTH	LONGUEUR DE CABLE	
60	60" CABLE (STD LENGTH)	
**	CUSTOM CABLE LENGTH (PLEASE SPECIFY)	
	FOR OVERALL LENGTH, PLEASE CONTACT YOUR EUREKA REPRESENTATIVE.	
CANOPY FINISH	FINI PAVILLON	
BLKE	BLACK FINE TEXTURE	
WHE	WHITE FINE TEXTURE	
SHADE FINISH	FINI ABAT-JOUR ^(A)	
BLKE	BLACK FINE TEXTURE	
WHE	WHITE FINE TEXTURE	
	^(A) FINISH BETWEEN SHADES IS ALWAYS WHITE	
	^(B) HEATSINK IS ALWAYS BLACK	

ADDITIONAL OPTIONS AVAILABLE ON STANDARD SHIPPING / OPTIONS ADDITIONNELLES DISPONIBLES EN LIVRAISON STANDARD

PRODUCT CHARACTERISTICS CARACTÉRISTIQUES DU PRODUIT

BIM **DIM** **EMB** **IES** **LED**

TWIN 4768

QUICKSHIP
PROJECT PROJET
SPEC TYPE
NOTES



FINISH FINI



BLKE WHE

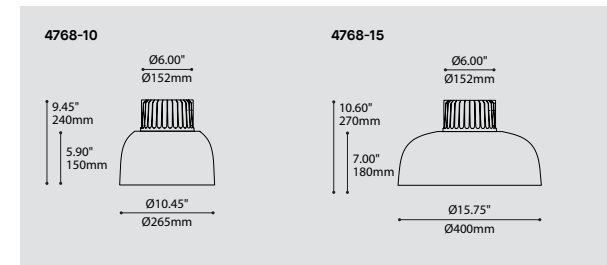

ORDERING SPECIFICATION	SPÉCIFICATION DE COMMANDE	CODE
QUICKSHIP		
QS5	QUICKSHIP 5 DAYS - MAXIMUM 5 UNITS	QUICKSHIP 5 JOURS - MAXIMUM 5 UNITÉS
QS10	QUICKSHIP 10 DAYS - MAXIMUM 20 UNITS	QUICKSHIP 10 JOURS - MAXIMUM 20 UNITÉS
MODEL	MODÈLE	
4768-10	TWIN 10"	
4768-15	TWIN 15"	
4768-10-DD*	TWIN 10" (DUAL DIMMING)	
4768-15-DD*	TWIN 15" (DUAL DIMMING)	
	*INNER AND OUTER LIGHT SOURCES ARE DIMMED INDEPENDANTLY	
LIGHT SOURCE	SOURCE LUMINEUSE	LED
LED	REGULAR OUTPUT	
COLOR TEMPERATURE	TEMPÉRATURE DE COULEUR	
30	3000K	
35	3500K	
40	4000K	
COLOR RENDERING INDEX (CRI)	INDICE DE RENDU DE COULEUR (IRC)	80
80	80+ CRI	
VOLTAGE	VOLTAGE	
120V	120 VOLT	
277V	277 VOLT	
DIMMING OPTION	OPTION DE GRADATION	
DV	0-10V DIMMING (120V-277V)	
DP	PHASE DIMMING (120V ONLY)	
	LED DIMMING DRIVER IS STANDARD IN THIS PRODUCT, PLEASE SPECIFY YOUR DIMMING TYPE.	
BEAM ANGLE	ANGLE DE FAISCEAU	40
40	40° LENS	
HEATSINK FINISH	FINI RADIATEUR	BLKE
BLKE	BLACK FINE TEXTURE	
WHE	WHITE FINE TEXTURE	
	^(A) FINISH BETWEEN SHADES IS ALWAYS WHITE	
ACCESSORY	ACCESSOIRE	3983
3983	DEEP JUNCTION BOX	

ADDITIONAL OPTIONS AVAILABLE ON STANDARD SHIPPING / OPTIONS ADDITIONNELLES DISPONIBLES EN LIVRAISON STANDARD

PRODUCT CHARACTERISTICS CARACTÉRISTIQUES DU PRODUIT

BIM **DIM** **EMB** **IES** **LED**

DESIGN:	Twin is a light fixture with a simple and charming shape composed of a double layered shade sheltering a soft halo of indirect light. The core of these two shades hides a powerful projector providing a strong direct light. Twin is available in two sizes and in a variety of colorful finishes.
INSTALLATION:	Ceiling installation on deep junction box (supplied with light fixture).
LIGHT SOURCE:	Powerful LED projector with a 20° or 40° projection angle, and a circular LED module that projects a soft and cozy indirect light, diffused between the shades. Offered with phase or 0-10V gradation options.
STRUCTURE:	High-performance die-cast aluminum heatsink with textured black finish. Spun aluminum shades, offered in a wide variety of external finishes with a white internal finish for optimal light reflection.
CERTIFIED:	c-CSA-us, c-UL-us

TWIN 1208

QUICKSHIP

PROJECT PROJET

SPEC TYPE

NOTES



FINISH FINI

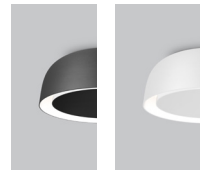

BLKE WHE

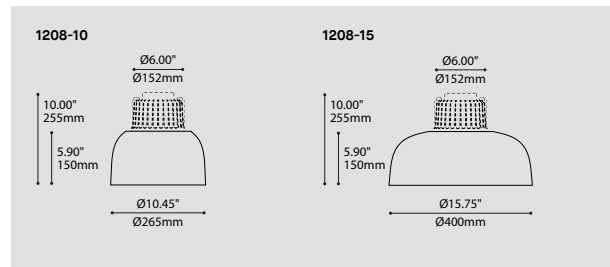

ORDERING SPECIFICATION SPÉCIFICATION DE COMMANDE

CODE

QUICKSHIP

QS5 QUICKSHIP 5 DAYS - MAXIMUM 5 UNITS QUICKSHIP 5 JOURS - MAXIMUM 5 UNITÉS
QS10 QUICKSHIP 10 DAYS - MAXIMUM 20 UNITS QUICKSHIP 10 JOURS - MAXIMUM 20 UNITÉS

MODEL MODÈLE

1208-10 TWIN 10"
1208-15 TWIN 15"
1208-10-DD* TWIN 10" (DUAL DIMMING)
1208-15-DD* TWIN 15" (DUAL DIMMING)
*INNER AND OUTER LIGHT SOURCES ARE DIMMED INDEPENDANTLY

LIGHT SOURCE SOURCE LUMINEUSE

LED REGULAR OUTPUT

COLOR TEMPERATURE TEMPÉRATURE DE COULEUR

30 3000K
35 3500K
40 4000K

COLOR RENDERING INDEX (CRI) INDICE DE RENDU DE COULEUR (IRC)

80 80+ CRI

VOLTAGE VOLTAGE

120V 120 VOLT
277V 277 VOLT

DIMMING OPTION OPTION DE GRADATION

DV 0-10V DIMMING (120V-277V)
DP PHASE DIMMING (120V ONLY)
LED DIMMING DRIVER IS STANDARD IN THIS PRODUCT, PLEASE SPECIFY YOUR DIMMING TYPE.

BEAM ANGLE ANGLE DE FAISCEAU

40 40° LENS

SHADE FINISH FINI ABAT-JOUR (A)

BLKE BLACK FINE TEXTURE
WHE WHITE FINE TEXTURE
(A) FINISH BETWEEN SHADES IS ALWAYS WHITE

ADDITIONAL OPTIONS AVAILABLE ON STANDARD SHIPPING / OPTIONS ADDITIONNELLES DISPONIBLES EN LIVRAISON STANDARD

PRODUCT CHARACTERISTICS CARACTÉRISTIQUES DU PRODUIT



DESIGN: Twin is a light fixture with a simple and charming shape composed of a double layered shade sheltering a soft halo of indirect light. The core of these two shades hides a powerful projector providing a strong direct light. Twin is available in two sizes and in a variety of colorful finishes.

INSTALLATION: Recessed mounting system allows for simple and secure installation in a variety of ceiling types from 0.375" (9.5mm) to 2.75" (70mm) thick, accommodating renovation projects.

LIGHT SOURCE: Powerful LED projector with a 20° or 40° projection angle, and a circular LED module that projects a soft and cozy indirect light, diffused between the shades. Offered with phase or 0-10V gradation options.

STRUCTURE: High-performance die-cast aluminum heatsink with textured black finish. Spun aluminum shades, offered in a wide variety of external finishes with a white internal finish for optimal light reflection.

CERTIFIED: c-CSA-us



TUMBLER 3409

QUICKSHIP

PROJECT PROJET

SPEC TYPE

NOTES

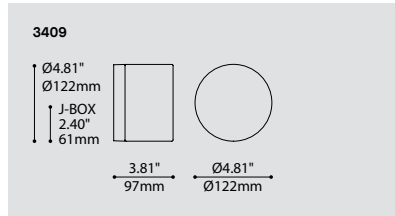

ORDERING SPECIFICATION SPÉCIFICATION DE COMMANDE

QUICKSHIP		CODE
QS5	QUICKSHIP 5 DAYS - MAXIMUM 5 UNITS	QUICKSHIP 5 JOURS - MAXIMUM 5 UNITÉS
QS10	QUICKSHIP 10 DAYS - MAXIMUM 20 UNITS	QUICKSHIP 10 JOURS - MAXIMUM 20 UNITÉS
MODEL MODÈLE	3409	
3409	TUMBLER	
LIGHT SOURCE SOURCE LUMINEUSE		
LED.4	4W, LED	
LED.8	8W, LED	
COLOR TEMPERATURE TEMPÉRATURE DE COULEUR		
30	3000K	
35	3500K	
40	4000K	
VOLTAGE VOLTAGE		
120V	120 VOLT	
277V	277 VOLT	
DIMMING OPTION OPTION DE GRADATION		
DV*	0-10V DIMMING (120V-277V)	
DP*	PHASE DIMMING (120V ONLY)	
	*3983 ACCESSORY IS PROVIDED FOR DIMMING OPTION	
STRUCTURE FINISH FINI STRUCTURE		
ANTE	ANTHRACITE FINE TEXTURE	
BLKE	BLACK FINE TEXTURE	
DIFFUSER FINISH FINI DIFFUSEUR	CFR	
CFR	CLEAR - FROSTED	
ACCESSORY ACCESSOIRE		
3983	DEEP JUNCTION BOX (PROVIDED FOR DIMMING OPTION)	

ADDITIONAL OPTIONS AVAILABLE ON STANDARD SHIPPING / OPTIONS ADDITIONNELLES DISPONIBLES EN LIVRAISON STANDARD

PRODUCT CHARACTERISTICS CARACTÉRISTIQUES DU PRODUIT



DESIGN:	Tumbler is a small jewel made from tough machined glass. Its crisp, minimal form provides seamless accent illumination for any indoor or outdoor environment.
LIGHT SOURCE:	Custom designed energy saving LED light source. Tumbler has an integral heatsink and has been tested to assure a long lifetime.
STRUCTURE:	Die-cast aluminum base with anthracite or black exterior grade fine texture finish. Designed to be both beautiful and durable, Tumbler is a machined heavy glass with an inside frosted surface for better diffusion.
DIFFUSER:	
CERTIFIED:	CSA Listed to US and Canadian safety standards; 25°C ambient and wet-locations. IP65 rated
CONCEPTION:	Le Tumbler est un petit bijou fait de verre machiné robuste. Sa forme géométrique minimaliste procure une lumière ambiante diffuse qui réhausse tout environnement intérieur ou extérieur.
SOURCE LUMINEUSE:	Modèle DEL conçu sur mesure à faible consommation. Le Tumbler intègre un dissipateur de chaleur testé pour prolonger sa durée de vie.
STRUCTURE:	Base en aluminium moulé sous pression finition peinture anthracite ou noire finement texturée de grade extérieur.
DIFFUSER:	Conçu pour être à la fois beau et durable, le Tumbler est machiné à même un bloc de verre et est ensuite givré à l'intérieur pour une meilleure diffusion.
CERTIFIÉ:	Homologué CSA aux standards UL Canada et É.-U. - Température ambiante 25°C et emplacements mouillés. Conforme à la norme IP65



QUICKSHIP

VALCO 4259

QUICKSHIP
PROJECT PROJET
SPEC TYPE
NOTES



FINISH FINI



ANTE

WHE

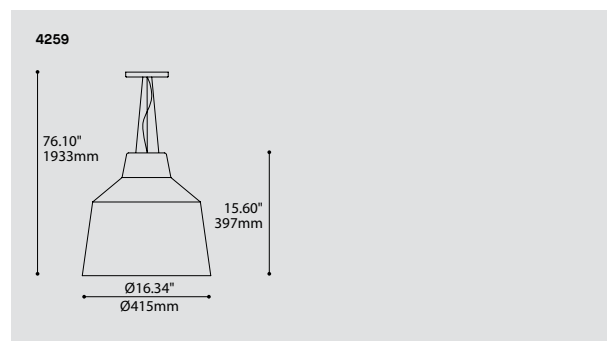

ORDERING SPECIFICATION	SPECIFICATION DE COMMANDE	CODE
QUICKSHIP		
QS5	QUICKSHIP 5 DAYS - MAXIMUM 5 UNITS	QUICKSHIP 5 JOURS - MAXIMUM 5 UNITÉS
QS10	QUICKSHIP 10 DAYS - MAXIMUM 20 UNITS	QUICKSHIP 10 JOURS - MAXIMUM 20 UNITÉS
MODEL MODÈLE		4259
4259	VALCO	
LIGHT SOURCE SOURCE LUMINEUSE		LED.24
LED.24	24W, LED	
COLOR TEMPERATURE TEMPÉRATURE DE COULEUR		
30	3000K	
35	3500K	
40	4000K	
COLOR RENDERING INDEX (CRI) INDICE DE RENDU DE COULEUR (IRC)		80
80	80+ CRI	
VOLTAGE VOLTAGE		
120V	120 VOLT	
277V	277 VOLT	
DIMMING OPTION OPTION DE GRADATION		
DV	0-10V DIMMING (120V-277V)	
DP	PHASE DIMMING (120V ONLY)	
	LED DIMMING DRIVER IS STANDARD IN THIS PRODUCT, PLEASE SPECIFY YOUR DIMMING TYPE	
CABLE CÂBLE		AC
AC	AIR-CRAFT MOUNTING & CLEAR CABLE, FIELD ADJUSTABLE	
CABLE LENGTH LONGUEUR DE CÂBLE		
60	60" AIRCRAFT CABLE (STD LENGTH)	
**	CUSTOM AIRCRAFT CABLE LENGTH (PLEASE SPECIFY)	
	FOR OVERALL LENGTH, PLEASE CONTACT YOUR EUREKA REPRESENTATIVE	
CANOPY FINISH FINI PAVILLON		WHE
WHE	WHITE FINE TEXTURE	
SHADE FINISH FINI ABAT-JOUR		
WHE	WHITE FINE TEXTURE	
ANTE	ANTHRACITE FINE TEXTURE	

ADDITIONAL OPTIONS AVAILABLE ON STANDARD SHIPPING / OPTIONS ADDITIONNELLES DISPONIBLES EN LIVRAISON STANDARD

PRODUCT CHARACTERISTICS CARACTÉRISTIQUES DU PRODUIT

BIM **DIM** **EMB** **IES** **LED**

DESIGN:	The minimalist silhouette distinguishes itself by its unique lines which gives it a contemporary tone. Suspended alone or in a group, Valco creates a soft and comfortable illumination throughout the room.
INSTALLATION:	Easy to install, adjust and level triple aircraft cable mounting.
LIGHT SOURCE:	24W custom LED light engine supplied with a standard dimming driver (0-10V or phase).
STRUCTURE:	Die-formed steel canopy with a machined aluminum diffuser support.
SHADE:	Custom spun aluminum shade anthracite or white architectural grade fine texture finishes.
CERTIFIED:	c-CSA-us
CONCEPTION:	Ce luminaire à la silhouette épurée se distingue par ses arêtes prononcées qui lui donnent un ton actuel. Suspendu seul ou en groupe, il crée une douce illumination à travers la pièce.
INSTALLATION:	Câbles de retenue en acier facilitant l'installation, l'ajustement et la mise à niveau.
SOURCE LUMINEUSE:	Module lumineux DEL de 24W fait sur mesure et unité d'alimentation à intensité variable standard (0-10V ou phase).
STRUCTURE:	Structure d'acier et support à diffuseur usiné en aluminium.
ABAT-JOUR:	Abat-jour en métal repoussé avec une peinture anthracite ou blanche finement texturée de grade architectural.
CERTIFIÉ:	c-CSA-us

VERNER 4273-14

QUICKSHIP
PROJECT PROJET
SPEC TYPE
NOTES



FINISH FINI



BLKE

WHE

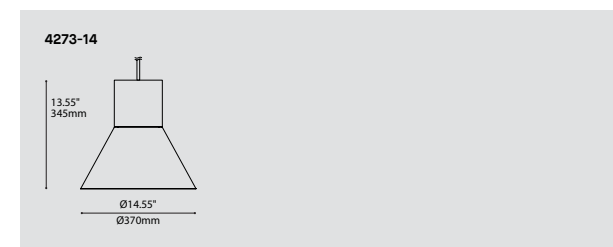

ORDERING SPECIFICATION	SPECIFICATION DE COMMANDE	CODE
QUICKSHIP		
QS5	QUICKSHIP 5 DAYS - MAXIMUM 5 UNITS	QUICKSHIP 5 JOURS - MAXIMUM 5 UNITÉS
QS10	QUICKSHIP 10 DAYS - MAXIMUM 20 UNITS	QUICKSHIP 10 JOURS - MAXIMUM 20 UNITÉS
MODEL MODÈLE		4273-14
4273-14	VERNER	
LIGHT SOURCE SOURCE LUMINEUSE		
LED	REGULAR OUTPUT	
LED.HO	HIGH OUTPUT	
COLOR TEMPERATURE TEMPÉRATURE DE COULEUR		
30	3000K	
35	3500K	
40	4000K	
COLOR RENDERING INDEX (CRI) INDICE DE RENDU DE COULEUR (IRC)		80
80	80+ CRI	
VOLTAGE VOLTAGE		
120V	120 VOLT	
277V	277 VOLT	
DIMMING OPTION OPTION DE GRADATION		
DV	0-10V DIMMING (120V-277V)	
DP	PHASE DIMMING (120V ONLY)	
	LED DIMMING DRIVER IS STANDARD IN THIS PRODUCT, PLEASE SPECIFY YOUR DIMMING TYPE.	
STEM OR CABLE TIGE OU CÂBLE		C
C	CABLE, FIELD ADJUSTABLE	
STEM OR CABLE LENGTH LONGUEUR DE TIGE OU CÂBLE		
60	60" CABLE (STD LENGTH)	
**	CUSTOM CABLE LENGTH (PLEASE SPECIFY)	
	FOR OVERALL LENGTH, PLEASE CONTACT YOUR EUREKA REPRESENTATIVE.	
CANOPY FINISH FINI PAVILLON		
BLKE	BLACK FINE TEXTURE	
WHE	WHITE FINE TEXTURE	
SHADE FINISH FINI ABAT-JOUR ^{(A)(B)}		
BLKE	BLACK FINE TEXTURE	
WHE	WHITE FINE TEXTURE	
	^(A) SHADE INTERIOR IS ALWAYS WHITE	
	^(B) SHADE FINISH DICTATES THE CABLE COLOR	
DIFFUSER FINISH FINI DIFFUSEUR		WH
WH	WHITE	

ADDITIONAL OPTIONS AVAILABLE ON STANDARD SHIPPING / OPTIONS ADDITIONNELLES DISPONIBLES EN LIVRAISON STANDARD

PRODUCT CHARACTERISTICS CARACTÉRISTIQUES DU PRODUIT

BIM **DIM** **EMB** **IES** **LED**

DESIGN:	Verner, at its core, is a powerful light engine fused to a timeless geometric aluminum shell. A diffusion dome hidden inside the shade makes for a pleasant surprise when you look up.
INSTALLATION:	Single power cable or stem for a minimalist look.
LIGHT SOURCE:	A highly powerful COB type light source project a light, softened by a polymer diffusion dome to create an illumination that is efficient, yet soft to the eye. Many control options available.
SHADE:	Precision spun aluminum shade, with a white internal finish for optimal light reflection.
CERTIFIED:	c-CSA-us



www.eurekalighting.com