

# ARENA – GLOW 8291

PROJECT PROJÉT
SPEC TYPE
NOTES

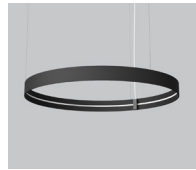

## FAMILY FAMILLE



ARENA 8200

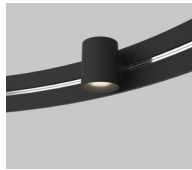

ARENA – BEAM 8290

## FINISH FINI



BLKE



ARENA – AIM 8292



ARENA – SLICE 8293



WHE



## ORDERING SPECIFICATION SPÉCIFICATION DE COMMANDE

CODE

### MODEL MODÈLE

8291

8291\* ARENA – GLOW  
\* ARENA ACCESSORY LIGHT SOURCE USED WITH ARENA 8200, 8210 and 8220 (SOLD SEPARATELY)

### LIGHT SOURCE SOURCE LUMINEUSE

LED

LED REGULAR OUTPUT, 8W  
TOTAL DC LOAD OF INSTALLED LIGHT SOURCES MUST NOT EXCEED MAXIMUM WATTAGE (SEE ARENA MAPPING PAGE).

### COLOR TEMPERATURE TEMPÉRATURE DE COULEUR

27 2700K  
30 3000K  
35 3500K  
40 4000K

### COLOR RENDERING INDEX INDICE DE RENDU DE COULEUR (IRC)

80 80+CRI

### PROJECTOR FINISH FINI PROJECTEUR

BLKE BLACK FINE TEXTURE  
WHE WHITE FINE TEXTURE

### OPTICAL ACCESSORIES ACCESSOIRES OPTIQUES

FRO

FRO FROSTED LENS

## PRODUCT CHARACTERISTICS CARACTÉRISTIQUES DU PRODUIT



### DESIGN:

With its thick clear-cut crystalline diffuser, ARENA – GLOW adds a touch of ambient luxury to the stately ARENA profile. Using the same 62mm body of ARENA – BEAM, the accessory rotates 90° in each direction and can be flipped vertically on the ring to enable direct or indirect illumination.

### INSTALLATION:

Magnetically positioned anywhere on the ARENA for easy on-site installation or reconfiguration of the lighting environment. A maximum of up to 12 ARENA – GLOW can be installed on each ARENA or can be combined with other accessories for a total load of up to 90W.

### LIGHT SOURCE:

COB LED combined with machined acrylic diffuser. The diffuser has a frosted interior surface for a smooth light diffusion and a perfectly polished exterior giving it a jewel-like look. Custom designed diecast aluminum heatsink offered in white or black architectural grade finish. c-CSA-us

### CONCEPTION:

Avec son diffuseur massif et cristallin, ARENA – GLOW ajoute une touche luxueuse à la suspension ARENA. En utilisant le même corps de 62 mm de ARENA – BEAM, l'accessoire pivote sur 90° dans chaque direction et peut être inversé sur l'anneau pour une illumination directe ou indirecte.

### INSTALLATION:

Positionné magnétiquement n'importe où sur l'ARENA pour faciliter l'installation ou la reconfiguration de l'éclairage sur site. Un maximum de 12 ARENA – GLOW peuvent être installés sur chaque ARENA ou être combinés avec d'autres accessoires jusqu'à une charge maximale de 90W.

### SOURCE LUMINEUSE:

LED de type COB combiné à un diffuseur en acrylique usiné. Le diffuseur a une surface intérieure givrée pour une diffusion douce de la lumière et un extérieur parfaitement poli lui attribuant un aspect luxueux.

### PROJECTEUR:

Dissipateur thermique en aluminium moulé conçu sur mesure offert avec une finition noire ou blanche de grade architectural.

### CERTIFIÉ:

c-CSA-us

## REFERENCE CHART TABLEAU DE RÉFÉRENCE

RING	LIGHT SOURCES				
	BEAM 8290	GLOW 8291	AIM 8292	SLICE RD 8293-36	SLICE RD 8293-54
ARENA 8200-36 & 8200-54					
MAXIMUM DC LOAD 90W	8W DC	8W DC	8W DC	8W DC	11W DC

# ARENA - GLOW 8291

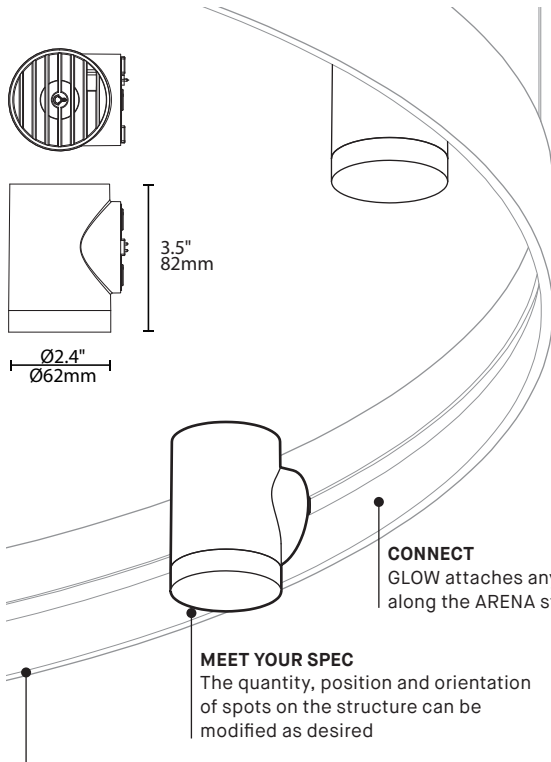

## A SOFT AMBIENT GLOW

With its thick clear-cut crystalline diffuser, the GLOW adds a touch of ambient luxury to the stately ARENA (8200) ring profile (sold separately). It can be displaced, flipped up or down and rotated left or right instantly without tools

**DIE-CAST ALUMINUM HEATSINK**  
Custom designed for optimal heat dissipation, black or white textured finish

**HIGH POWER COB LED**  
Single point source with high performance efficiency

**COMPACT REFLECTOR**  
Aluminum coated reflector for efficient light output

**SOLID DIFFUSER**  
A combination of clear and frosted acrylic diffuser for a jewel like appearance

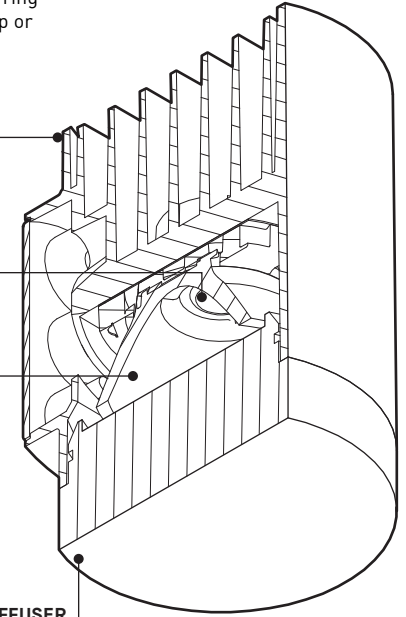

**CONNECT**  
GLOW attaches anywhere along the ARENA structure

**MEET YOUR SPEC**  
The quantity, position and orientation of spots on the structure can be modified as desired

**ARENA (8200,8210,8220) REQUIRED (SOLD SEPARATELY)**

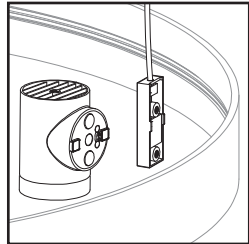

**Attach**  
Secured by strong neodymium magnets. Tested to UL standards to support several times its weight

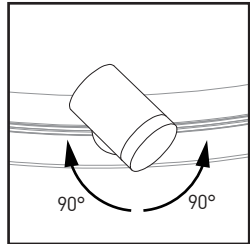

**Rotate**  
GLOW can be rotated sideways up to 90° in each direction to help highlight a particular area or object

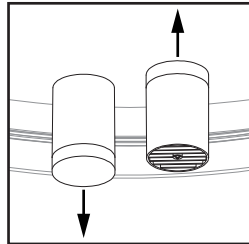

**Flip**  
GLOW can be flipped up or down for direct or indirect illumination

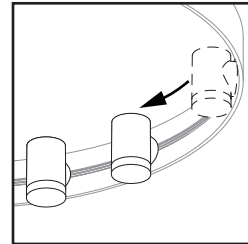

**Move**  
Position on the ARENA as desired to highlight areas below or create a visual pattern

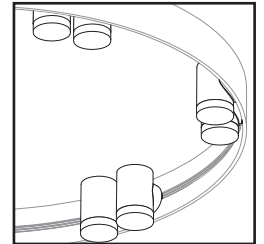

**Group**  
Place together to concentrate light in areas along the ARENA

## PRODUCT SPECIFICATION

8291

### PERFORMANCE

DC LAOD	8 W
DELIVERED LUMENS (4000K)	937 LM
EFFICACY (INCLUDING DRIVERS)	122 LM/W

### OTHER INFORMATIONS

OPTIC	MACHINED CLEAR ACRYLIC WITH FROSTED INNER FINISH
REFLECTOR (BEAM ANGLE)	MEDIUM (26°)
LUMINAIRE'S WEIGHT	0.7 LBS / 0.3 KG
L70 (LUMEN MAINTENANCE)	> 55 000 HRS

### EFFICACY MULTIPLIERS

CRI	CCT	FACTOR
80+	4000K	1.00
80+	3500K	0.99
80+	3000K	0.97
80+	2700K	0.94
90+	4000K	0.89
90+	3500K	0.86
90+	3000K	0.84
90+	2700K	0.80

### LIGHT DISTRIBUTION

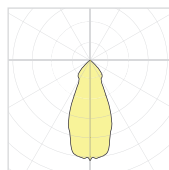

8291



Visit our website for warranty terms and conditions.



## TECHNICAL DATA

# ARENA - GLOW 8291

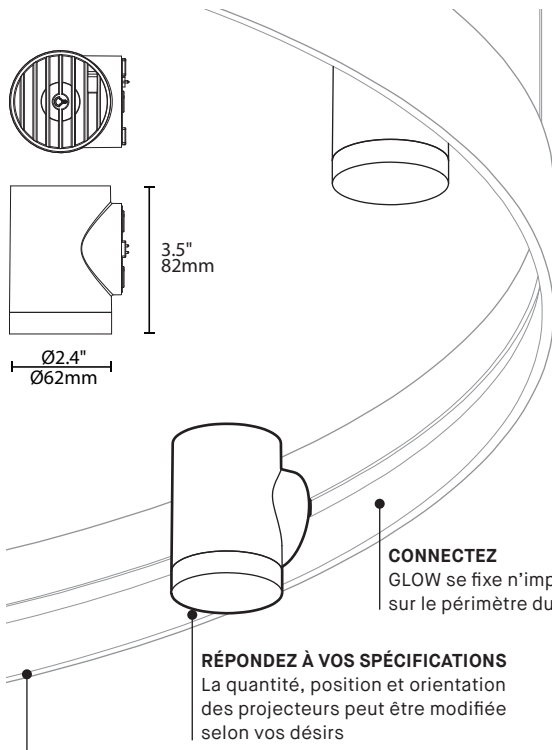

## UNE DOUCE LUEUR

Muni d'un épais diffuseur cristallin, le GLOW ajoute une touche de luxe au majestueux profil du ARENA (8200) vendu séparément. Il peut être déplacé, dirigé vers le haut ou le bas, pivoté de gauche à droite sans aucun outil

**DISSIPATEUR EN ALUMINIUM**  
Conçu sur mesure pour une dissipation thermique optimale. Offert en finis finement texturés noir ou blanc

**DEL COB HAUTE PUISSANCE**  
Source unique efficace et haute performance

**RÉFLECTEUR COMPACT**  
Réflecteur fini aluminium pour une sortie efficace de la lumière

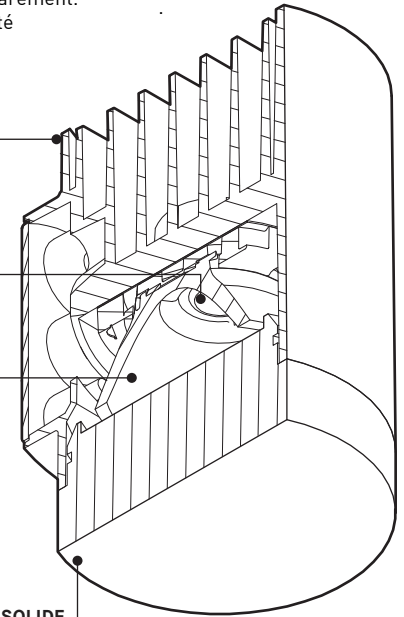

**DIFFUSEUR SOLIDE**  
Taillé dans l'acrylique tel un bijou, un diffuseur clair à l'extérieur et givré à l'intérieur

ARENA (8200,8210,8220) REQUIS (VENDU SÉPARÉMENT)

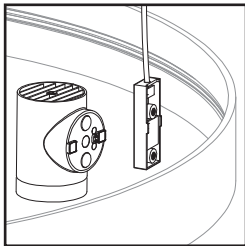

**Attachez**  
Sécurisé par de puissants aimants en néodyme. Testé selon UL pour supporter plusieurs fois leur poids

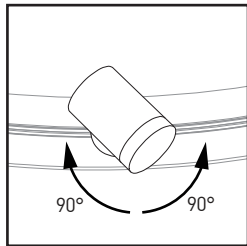

**Pivotez**  
GLOW peut être tourné 90° sur le coté dans chaque direction afin d'illuminer une zone ou un objet particulier

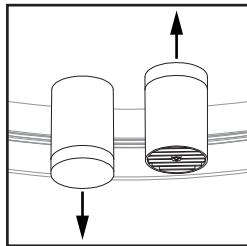

**Inversez**  
GLOW peut être tourné vers le haut ou le bas pour une illumination directe ou indirecte

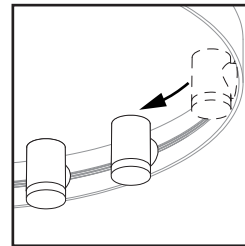

**Déplacez**  
Positionnez sur le ARENA tel que désiré afin d'illuminer des zones sous le luminaire ou créer des motifs visuels

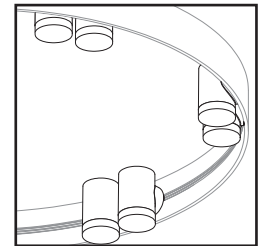

**Groupez**  
Placez ensemble afin de concentrer des zones de lumière le long du ARENA

## SPÉCIFICATION PRODUIT

8291

### PERFORMANCE

CHARGE DC	8 W
LUMENS RÉELS (4000K)	937 LM
EFFICACITÉ (INCLUANT UNITÉ D'ALIMENTATION)	122 LM/W

### AUTRES INFORMATIONS

<b>OPTIQUE</b>	ACRYLIQUE CLAIRE USINÉ AVEC FINI INTÉRIEUR GIVRÉ
<b>RÉFLECTEUR (ANGLE DE FAISCEAU)</b>	MEDIUM (26°)
<b>POIDS DU LUMINAIRE</b>	0.7 LBS / 0.3 KG
<b>L70 (MAINTENANCE DE LA LUMIÈRE)</b>	> 55 000 H

### FACTEUR D'EFFICACITÉ

### DISTRIBUTION LUMINEUSE

IRC	CCT	FACTEUR
80+	4000K	1.00
80+	3500K	0.99
80+	3000K	0.97
80+	2700K	0.94
90+	4000K	0.89
90+	3500K	0.86
90+	3000K	0.84
90+	2700K	0.80

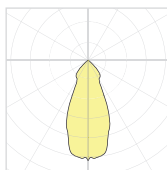

8291



Visitez notre site Web pour les termes et conditions.



## DONNÉES TECHNIQUES

# Arena Mapping

MIXING LIGHT SOURCES IS POSSIBLE AND RECOMMENDED. TO HELP YOU DO SO, SUBSTRACT THE DC LOAD OF EACH LIGHT SOURCE FROM THE MAXIMUM DC LOAD OF ARENA. DO NOT EXCEED MAXIMUM WEIGHT PER SIDE

<b>LUMINAIRE</b>	<b>FRAME CONFIGURATION</b> *REFER TO 2D DRAWINGS FOR EACH SIZE.	<b>ARENA RING</b>  8200-36 8200-54	<b>ARENA SQUARE &amp; RECTANGLE</b>			
			8220-36X36 8220-36X54	8220-54X54 8220-36X96 8220-54X96 8220-96X96	8220-36X190 8220-54X190 8220-96X190 8220-190X190	8220-36X380 8220-54X380 8220-96X380 8220-190X380 8220-380X380
	<b>MAXIMUM TOTAL DC LOAD OF ACCESSORY</b>	<b>90W DC</b>	<b>90W DC</b>	<b>180W</b> (90W DC PER 2 SIDES)	<b>360W</b> (90W DC PER SIDES)	<b>540W, 720W</b> (90W DC PER SECTION)
	<b>MAXIMUM TOTAL WEIGHT OF ACCESSORY</b>	<b>25 LBS</b>	<b>25 LBS / SIDE</b>	<b>25 LBS / SIDE</b>	<b>25 LBS / SECTION</b>	<b>25 LBS / SECTION</b>

<b>LUMINAIRE</b>	<b>FRAME CONFIGURATION</b> *REFER TO 2D DRAWINGS FOR EACH SIZE.	<b>ARENA STRAIGHT</b>		
		8210-36 (1 SECTION) 8210-54 (1 SECTION) 8210-70 (2 SECTIONS)	8210-96 (1 SECTION) 8210-158 (3 SECTIONS) 8210-190 (2 SECTIONS)	8210-284 (3 SECTIONS) 8210-380 (4 SECTIONS)
	<b>MAXIMUM TOTAL DC LOAD OF ACCESSORY</b>	<b>90W (90W DC FOR BOTH SIDES)</b>	<b>180W (90W DC PER SECTION)</b>	<b>360W DC (90W DC PER SECTION)</b>
	<b>MAXIMUM TOTAL WEIGHT OF ACCESSORY</b>	<b>25 LBS / SECTION</b>	<b>25 LBS / SECTION</b>	<b>25 LBS / SECTION</b>

<b>ACCESSORIES HEAD</b>	<b>LIGHT SOURCES</b>	<b>BEAM</b> 8290	<b>GLOW</b> 8291	<b>AIM</b> 8292	<b>CONE</b> 8294	<b>BALL</b> 8295
						
	<b>DC LOAD</b>	<b>8W DC</b>	<b>8W DC</b>	<b>8W DC</b>	<b>11W DC</b>	<b>8W DC</b>
	<b>WEIGHT LBS</b>	<b>0.62 LBS</b>	<b>0.70 LBS</b>	<b>0.61 LBS</b>	<b>0.88 LBS</b>	<b>0.48 LBS</b>

<b>ACCESSORIES SLICE</b>	<b>LIGHT SOURCES</b>	<b>SLICE-ROUND 8293 (ONLY FOR 8200)</b>		<b>SLICE-SQUARE 8296</b>	
		8293-36	8293-54	8296-36	8296-54
	<b>DC LOAD</b>	<b>8W DC</b>	<b>11W DC</b>	<b>8W DC</b>	<b>11W DC</b>
	<b>WEIGHT LBS</b>	<b>1.24 LBS</b>	<b>1.65 LBS</b>	<b>2.22 LBS</b>	<b>3.50 LBS</b>

<b>ACCESSORIES ADAPTER</b>	<b>LIGHT SOURCES</b>	<b>MILL 14"</b> 4277D-14	<b>SCOUT 02.75"</b> 4048-XX	<b>SCOUT 04"</b> 4049-XX	<b>MIKA 8"</b> 4230-8	<b>BLOOM</b> 4269-XX	<b>MINI MUTE</b> 4258-16	<b>CELESTE</b> 4010-CEL1
								
	<b>DC LOAD</b>	<b>8W DC</b>	<b>8W DC</b>	<b>8W DC</b>	<b>8W DC</b>	<b>8W DC</b>	<b>11W DC</b>	<b>4W DC</b>
	<b>WEIGHT LBS</b>	<b>11.3 LBS</b>	<b>MAX 4.32 LBS</b>	<b>MAX 6.05 LBS</b>	<b>2.40 LBS</b>	<b>MAX 9.75 LBS</b>	<b>5.83 LBS</b>	<b>2.20 LBS</b>

<b>ACCESSORIES ACOUSTIC</b>	<b>ACOUSTIC CONFIGURATION</b>	<b>ACOUSTIC BAFFLE FOR ARENA SQUARE</b>		<b>ACOUSTIC BAFFLE FOR ARENA STRAIGHT</b>	
		8297-40	8297-58	8298-40	8298-58
	<b>WEIGHT LBS</b>	<b>1.38 LBS / PANEL</b>	<b>1.63 LBS / PANEL</b>	<b>1.38 LBS / PANEL</b>	<b>1.63 LBS / PANEL</b>
	<b>CONFIGURATION USE FOR ARENA</b>	8220-36X36 8220-36X54 8220-36X96	8220-54X54 8220-36X54 8220-54X96	8210-XX 8220-XX	8210-XX 8220-XX

\*WE RESERVE THE RIGHT TO MODIFY ANY INFORMATION AT ANY TIME.

# ARENA 8200

PROJECT PROJÉT
SPEC TYPE
NOTES

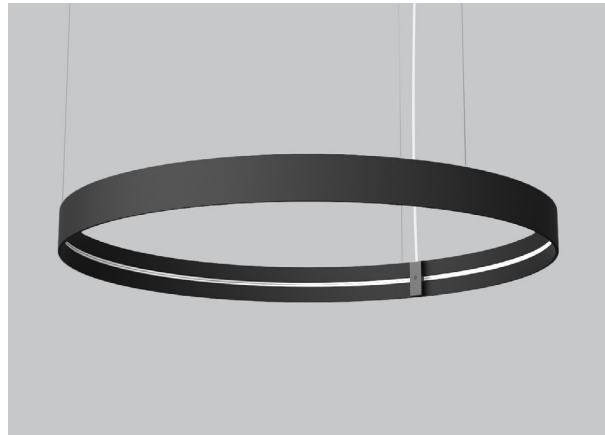

## FAMILY FAMILLE

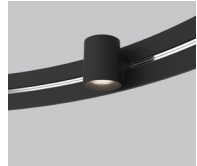

ARENA - BEAM 8290



ARENA - GLOW 8291

## FINISH FINI



BLKE



ARENA - SLICE 8293



ARENA - AIM 8292



WHE

## MOUNTING OPTIONS OPTIONS DE MONTAGE

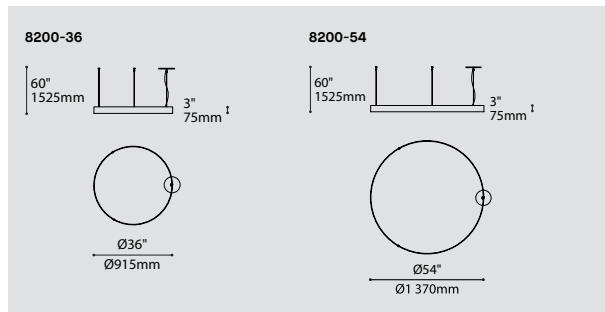
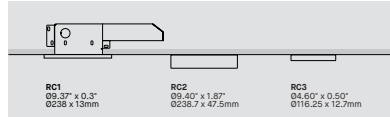

## ORDERING SPECIFICATION SPÉCIFICATION DE COMMANDE

CODE

### MODEL MODÈLE

8200-36 ARENA 36"  
 8200-54 ARENA 54"

### MAXIMUM DC LOAD PUISSANCE MAXIMALE DC

90W 90 WATT DC

90W

TOTAL DC LOAD OF INSTALLED LIGHT SOURCES MUST NOT EXCEED 90W. (see mapping page)

RING
ARENA 8200-36 & 8200-54
MAXIMUM DC LOAD 90W

LIGHT SOURCES				
BEAM 8290	GLOW 8291	AIM 8292	SLICE RD 8293-36	SLICE RD 8293-54
8W DC	8W DC	8W DC	8W DC	11W DC

### VOLTAGE VOLTAGE

120V 120 VOLT  
 277V 277 VOLT

### CONTROL OPTION OPTION DE CONTRÔLE

DV 0-10V DIMMING (120V-277V)  
 NLTAIR2\* NLIGHT AIR CONTROL GEN 2 (NOT AVAILABLE WITH MOUNTING OPTION RC3)  
 NLIGHT\* NLIGHT WIRED CONTROL (NOT AVAILABLE WITH MOUNTING OPTION RC3)  
 LED DIMMING DRIVER IS STANDARD IN THIS PRODUCT  
 \*NLIGHT INTEGRATION REQUIRES A REMOTE POWER PACK (39NLAA & 39NLWA AS BELOW FOR NLIGHT).  
 REFER TO NLIGHT GUIDE AND INSTALLATION SHEET FOR ALL REQUIREMENTS.

DV

### DRIVER POSITION POSITION DE L'ALIMENTATION

RDP \* RECESSED DRIVER  
 \* 3981C IS REQUIRED

### CABLE CÂBLE

AC AIRCRAFT MOUNTING & CLEAR CABLE, FIELD ADJUSTABLE

AC

### CABLE LENGTH LONGUEUR DE CÂBLE

60 60" AIRCRAFT CABLE (STD LENGTH)  
 \*\* CUSTOM AIRCRAFT CABLE LENGTH (PLEASE SPECIFY)  
 FOR OVERALL LENGTH, PLEASE CONTACT YOUR EUREKA REPRESENTATIVE.

### MOUNTING MONTAGE

RC1 ROUND CANOPY ON JBOX FOR RECESSED DRIVERS 0.5" (2475C)  
 RC2 ROUND SURFACE SCREWLESS CANOPY 1.87" (2475I)  
 RC3 ROUND SURFACE SCREWLESS CANOPY 0.50" FOR REMOTE DRIVER BOX 12"X16" (2471C)  
 \* PAIR WITH ACCESSORY 3981GA

RC

### MOUNTING CABLE OPTION OPTION DE MONTAGE DE CÂBLE

IF NO OPTION IS SELECTED, AN OFF-CENTERED ROUND CANOPY WITH STRAIGHT AIRCRAFT CABLES IS STANDARD

RCC CENTERED ROUND CANOPY - STRAIGHT AIRCRAFT CABLES

### CANOPY FINISH FINI PAVILLON

BLKE BLACK FINE TEXTURE  
 WHE WHITE FINE TEXTURE

### POWER CORD FINISH FINI CÂBLE D'ALIMENTATION

BLK BLACK POWER CORD  
 WH WHITE POWER CORD  
 CLR CLEAR POWER CORD

### RING FINISH FINI DE L'ANNEAU

BLKE BLACK FINE TEXTURE  
 WHE WHITE FINE TEXTURE

### ACCESSORY ACCESSOIRE

3981C JUNCTION BOX FOR RECESSED DRIVER OPTION SQ1 OR RC1  
 3981GA REMOTE DRIVER BOX 12"X16" FOR MOUNTING RC3 FOR DC LOAD 90W  
 39NLAA\* NLIGHT AIR GEN 2 REMOTE CONTROLLER (NOT AVAILABLE WITH MOUNTING OPTION RC3)  
 39NLWA\* NLIGHT WIRED REMOTE CONTROLLER (NOT AVAILABLE WITH MOUNTING OPTION RC3)  
 \* FOR CHICAGO PLENUM INSTALLATION, PLEASE CONTACT YOUR EUREKA REPRESENTATIVE.



SPECIFICATION

# ARENA STRAIGHT 8210

PROJECT PROJÉT
SPEC TYPE
NOTES



## FINISH FINI

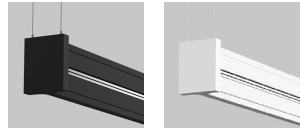

BLKE

WHE

## FAMILY FAMILLE



ARENA - BEAM 8290

ARENA - GLOW 8291

ARENA - AIM 8292

ARENA - BALL 8295



ARENA - CONE 8294

ARENA - SLICE SQ 8296

ARENA - ACOUSTIC 8298

## MOUNTING CABLE OPTION OPTION DE MONTAGE DE CÂBLE

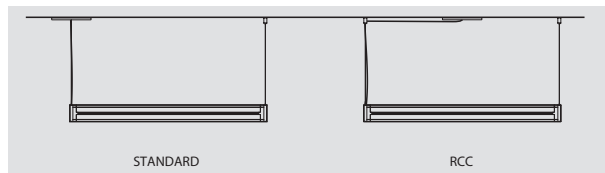

STANDARD

RCC

## ORDERING SPECIFICATION SPÉCIFICATION DE COMMANDE

CODE

### STANDARD MODEL MODÈLE STANDARD

<b>8210-36</b>	ARENA STRAIGHT 36"
<b>8210-54</b>	ARENA STRAIGHT 54"
<b>8210-70</b>	ARENA STRAIGHT 70" (2 SECTIONS CONNECTED WITH 1 JOINER)
<b>8210-96</b>	ARENA STRAIGHT 96"
<b>8210-158</b>	ARENA STRAIGHT 158" (3 SECTIONS CONNECTED WITH 2 JOINERS)
<b>8210-190</b>	ARENA STRAIGHT 190" (2 SECTIONS CONNECTED WITH 1 JOINER)
<b>8210-285</b>	ARENA STRAIGHT 285" (3 SECTIONS CONNECTED WITH 2 JOINERS)
<b>8210-380</b>	ARENA STRAIGHT 380" (4 SECTIONS CONNECTED WITH 3 JOINERS)

FOR CUSTOM SIZES, PLEASE CONTACT YOUR EUREKA REPRESENTATIVE.

### DC LOAD PUISSANCE MAXIMALE DC

<b>90W</b>	1X 90 WATT (AVAILABLE FROM 36" TO 96")
<b>180W</b>	2X 90 WATT (AVAILABLE FROM 36" TO 190")
<b>360W</b>	4X 90 WATT (ONLY AVAILABLE FOR 285" TO 380")

ARENA STRAIGHT 8210	LIGHT SOURCES							ADAPTER TAA
	BEAM 8290	GLOW 8291	AIM 8292	SLICE-SQ 8296-36	SLICE-SQ 8296-54	BALL 8295	CONE 8294	
MAXIMUM DC LOAD 90W, 180W, 360W	8W DC	8W DC	8W DC	8W DC	11W DC	8W DC	11W DC	SEE SPEC SHEET
MAXIMUM TOTAL WEIGHT PER SECTION 25 LBS	0.62 LBS	0.70 LBS	0.61 LBS	2.22 LBS	3.50 LBS	0.48 LBS	0.88 LBS	

### VOLTAGE VOLTAGE

<b>120V</b>	120 VOLT
<b>277V</b>	277 VOLT

### CONTROL OPTIONS OPTION DE CONTRÔLE

<b>DV</b>	0-10V DIMMING (120V-277V)
<b>NLTAIR2*</b>	NLIGHT AIR CONTROL GEN2 (NOT AVAILABLE WITH MOUNTING OPTION RC3)
<b>NLIGHT*</b>	NLIGHT WIRED CONTROL (NOT AVAILABLE WITH MOUNTING OPTION RC3)

LED DIMMING DRIVER IS STANDARD IN THIS PRODUCT  
\*NLIGHT INTEGRATION REQUIRES A REMOTE POWER PACK (39NLAA & 39NLWA AS BELOW FOR NLIGHT). REFER TO NLIGHT GUIDE AND INSTALLATION SHEET FOR ALL REQUIREMENTS.

### CABLE CÂBLE

<b>AC</b>	AIRCRAFT CABLE & POWER CORD, FIELD ADJUSTABLE
-----------	---

AC

### CABLE LENGTH LONGUEUR DE CÂBLE

<b>60</b>	60" AIRCRAFT CABLE (STD LENGTH)
<b>**</b>	CUSTOM AIRCRAFT CABLE LENGTH (PLEASE SPECIFY) FOR OVERALL LENGTH, PLEASE CONTACT YOUR EUREKA REPRESENTATIVE.

### MOUNTING MONTAGE

<b>SQ1</b>	SQUARE CANOPY ON JBOX FOR RECESSED DRIVERS 6.6" (2437B) (PAIR WITH 3981C OR 3981D)
<b>RC1</b>	ROUND CANOPY ON JBOX FOR RECESSED DRIVERS 8.9" (2404B) (PAIR WITH 3981C OR 3981D)
<b>RC2</b>	ROUND SURFACE SCREWLESS CANOPY 9.4" FOR 90W ONLY (2475I)
<b>RC3</b>	ROUND SURFACE SCREWLESS CANOPY 4.6" FOR REMOTE DRIVER BOX 12"X16" (2471C) (PAIR WITH ACCESSORY 3981GA OR 3981GB)
<b>RC4</b>	ROUND SURFACE SCREWLESS CANOPY 12" FOR 180W OR 360W (2477I)

### MOUNTING CABLE OPTION OPTION DE MONTAGE DE CÂBLE

<b>RCC</b>	FLOATING CANOPY - STRAIGHT AIRCRAFT CABLES IF NO OPTION IS SELECTED, A CANOPY AT END OF THE FIXTURE WITH AIRCRAFT CABLES IS STANDARD
------------	---

### CANOPY & GRIPPERS FINISH FINI PAVILLON ET ATTACHES

<b>BLKE</b>	BLACK FINE TEXTURE
<b>WHE</b>	WHITE FINE TEXTURE

### POWER CORD FINISH FINI CÂBLE D'ALIMENTATION

<b>BLK</b>	BLACK POWER CORD
<b>WH</b>	WHITE POWER CORD
<b>CLR</b>	CLEAR POWER CORD

### FRAME FINISH FINI DU CADRE

<b>BLKE</b>	BLACK FINE TEXTURE
<b>WHE</b>	WHITE FINE TEXTURE

## MOUNTING OPTION OPTION DE MONTAGE

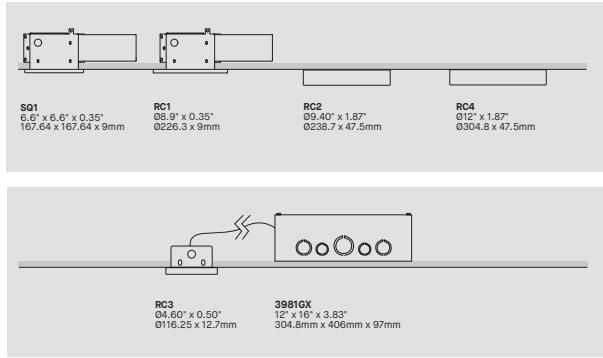

## ACCESSORY ACCESSOIRE

- 3981C** 1 JUNCTION BOX FOR 90W RECESSED DRIVER
- 3981D** 1 JUNCTION BOX FOR 180W RECESSED DRIVER
- 3981D2** 2 JUNCTION BOX FOR 360W RECESSED DRIVER
- 3981GA** 1 REMOTE DRIVER BOX 12"X16" FOR MOUNTING RC3 FOR DC LOAD 90W
- 3981GB** 1 REMOTE DRIVER BOX 12"X16" FOR MOUNTING RC3 FOR DC LOAD 180W
- 3981GB2** 2 REMOTE DRIVER BOXES 12"X16" FOR MOUNTING RC3 FOR DC LOAD 360W
- 39NLAA\*** NLIGHT AIR GEN 2 REMOTE CONTROLLER (NOT AVAILABLE WITH MOUNTING OPTION RC3)
- 39NLWA\*** NLIGHT WIRED REMOTE CONTROLLER (NOT AVAILABLE WITH MOUNTING OPTION RC3)

\* FOR CHICAGO PLENUM INSTALLATION, PLEASE CONTACT YOUR EUREKA REPRESENTATIVE

# ARENA STRAIGHT 8210

## CONFIGURATIONS

**8210-36**  
ARENA STRAIGHT 36"

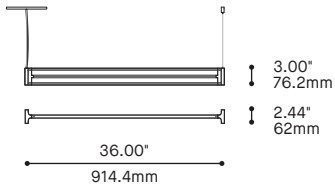

**8210-54**  
ARENA STRAIGHT 54"

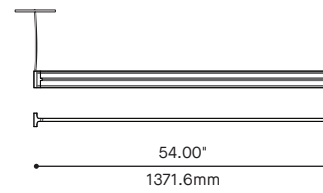

**8210-70**  
ARENA STRAIGHT 70.4"

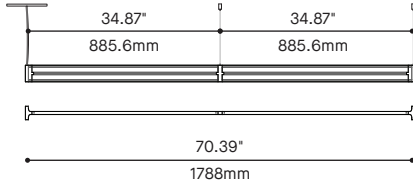

**8210-96**  
ARENA STRAIGHT 96"

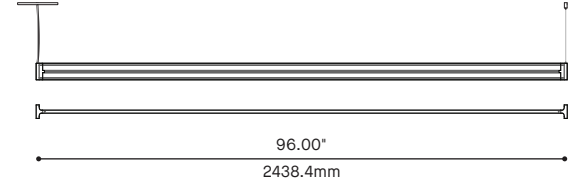

**8210-158**  
ARENA STRAIGHT 158.78"

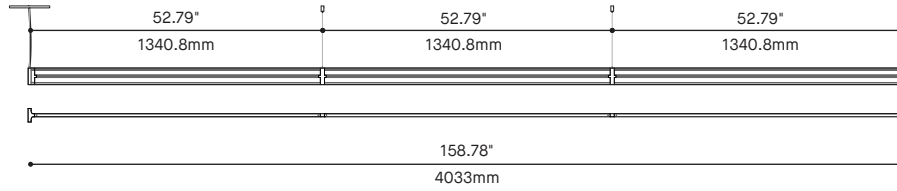

**8210-190**  
ARENA STRAIGHT 190.39"

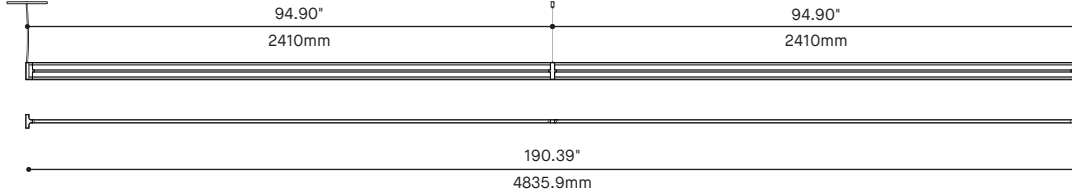

**8210-284**  
ARENA STRAIGHT 284.7"

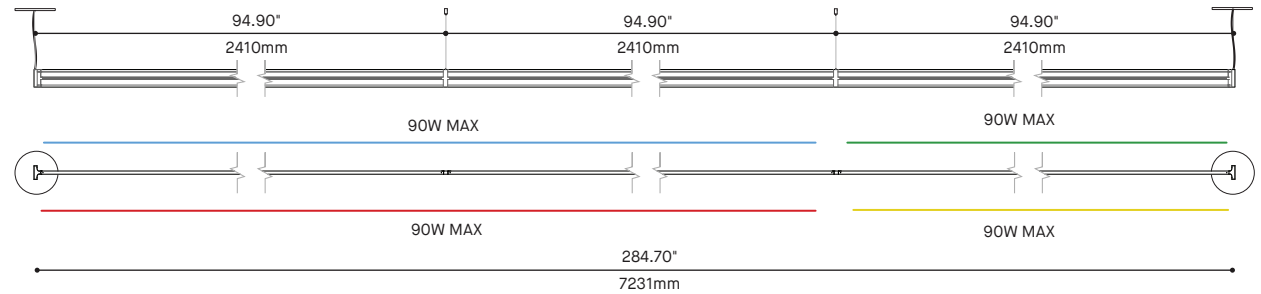

**8210-380**  
ARENA STRAIGHT 379.6"

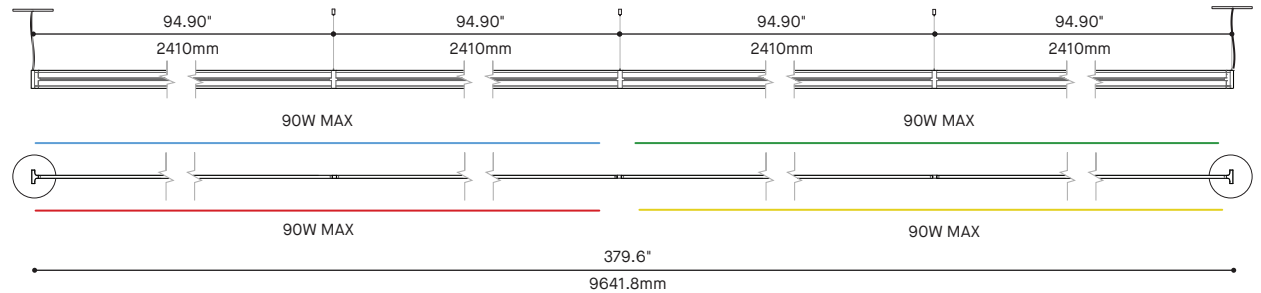



# ARENA SQUARE & RECTANGLE 8220

PROJECT PROJÉT
SPEC TYPE
NOTES

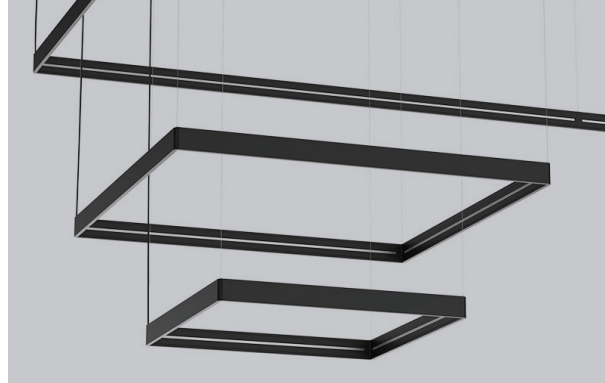

## FINISH FINI

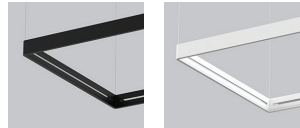

BLKE

WHE

## FAMILY FAMILLE



ARENA - BEAM 8290

ARENA - GLOW 8291

ARENA - AIM 8292

ARENA - BALL 8295

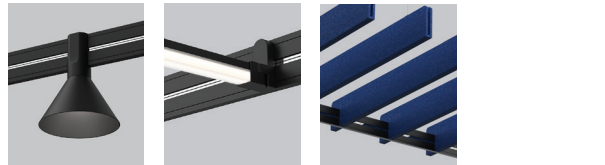

ARENA - CONE 8294

ARENA - SLICE SQ 8296

ARENA - ACOUSTIC 8298

## MOUNTING CABLE OPTION OPTION DE MONTAGE DE CÂBLE

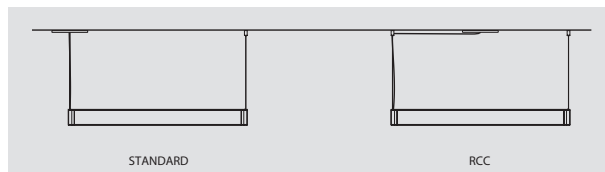

STANDARD

RCC

## ORDERING SPECIFICATION SPÉCIFICATION DE COMMANDE

CODE

### STANDARD MODEL MODÈLE STANDARD

8220-36X36	ARENA SQUARE 36X36"	8220-36X190	ARENA RECTANGLE 36X190"
8220-54X54	ARENA SQUARE 54X54"	8220-54X190	ARENA RECTANGLE 54X190"
8220-96X96	ARENA SQUARE 96X96"	8220-96X190	ARENA RECTANGLE 96X190"
8220-190X190	ARENA SQUARE 190X190"	8220-36X380	ARENA RECTANGLE 36X380"
8220-380X380	ARENA SQUARE 380X380"	8220-54X380	ARENA RECTANGLE 54X380"
8220-36X54	ARENA RECTANGLE 36X54"	8220-96X380	ARENA RECTANGLE 96X380"
8220-36X96	ARENA RECTANGLE 36X96"	8220-190X380	ARENA RECTANGLE 190X380"
8220-54X96	ARENA RECTANGLE 54X96"		

FOR CUSTOM SIZES, PLEASE CONTACT YOUR EUREKA REPRESENTATIVE.

### DC LOAD PUISSANCE MAXIMALE DC

90W	1 CANOPY / 1 DRIVER OF 90W
180W	1 CANOPY / 2 DRIVERS OF 90W
360W	2 CANOPY / 4 DRIVERS OF 90W
540W	4 CANOPY / 6 DRIVERS OF 90W
720W	4 CANOPY / 8 DRIVERS OF 90W

8220	36"	54"	96"	190"	380"
36"	90W				
54"		180W	180W	360W	540W
96"					
190"					
380"					720W

ARENA SQUARE 8220
MAXIMUM DC LOAD SEE TABLE
MAXIMUM TOTAL WEIGHT PER SECTION 25 LBS

LIGHT SOURCES							
BEAM 8290	GLOW 8291	AIM 8292	SLICE-SQ 8296-36	SLICE-SQ 8296-54	BALL 8295	CONE 8294	ADAPTER TAA
8W DC	8W DC	8W DC	8W DC	11W DC	8W DC	11W DC	SEE SPEC SHEET
0.62 LBS	0.70 LBS	0.61 LBS	2.22 LBS	3.50 LBS	0.48 LBS	0.88 LBS	

### VOLTAGE VOLTAGE

120V	120 VOLT
277V	277 VOLT

### CONTROL OPTIONS OPTION DE CONTRÔLE

DV	0-10V DIMMING (120V-277V)
NLTAIR2*	NLIGHT AIR CONTROL GEN2 (NOT AVAILABLE WITH MOUNTING OPTION RC3)
NLIGHT*	NLIGHT WIRED CONTROL (NOT AVAILABLE WITH MOUNTING OPTION RC3) LED DIMMING DRIVER IS STANDARD IN THIS PRODUCT *NLIGHT INTEGRATION REQUIRES A REMOTE POWER PACK (39NLAA & 39NLWA AS BELOW FOR NLIGHT). REFER TO NLIGHT GUIDE AND INSTALLATION SHEET FOR ALL REQUIREMENTS.

### CABLE CÂBLE

AC	AIRCRAFT CABLE & POWER CORD, FIELD ADJUSTABLE
----	---

AC

### CABLE LENGTH LONGUEUR DE CÂBLE

60	60" AIRCRAFT CABLE (STD LENGTH)
**	CUSTOM AIRCRAFT CABLE LENGTH (PLEASE SPECIFY) FOR OVERALL LENGTH, PLEASE CONTACT YOUR EUREKA REPRESENTATIVE.

### MOUNTING MONTAGE

SQ1	SQUARE CANOPY ON JBOX FOR RECESSED DRIVERS 6.6" (2437B) (PAIR WITH 3981C OR 3981D)
RC1	ROUND CANOPY ON JBOX FOR RECESSED DRIVERS 8.9" (2404B) (PAIR WITH 3981C OR 3981D)
RC2	ROUND SURFACE SCREWLESS CANOPY 9.4" FOR 90W ONLY (2475I)
RC3	ROUND SURFACE SCREWLESS CANOPY 4.6" FOR REMOTE DRIVER BOX 12"X16" (2471C) (PAIR WITH ACCESSORY 3981GA OR 3981GB)
RC4	ROUND SURFACE SCREWLESS CANOPY 12" FOR 180W OR 360W (2477I)

### MOUNTING CABLE OPTION OPTION DE MONTAGE DE CÂBLE

RCC	FLOATING CANOPY - STRAIGHT AIRCRAFT CABLES IF NO OPTION IS SELECTED, A CANOPY AT CORNERS OF THE FIXTURE WITH AIRCRAFT CABLES IS STANDARD
-----	---

### CANOPY & GRIPPERS FINISH FINI PAVILLON ET ATTACHES

BLKE	BLACK FINE TEXTURE
WHE	WHITE FINE TEXTURE

### POWER CORD FINISH FINI CÂBLE D'ALIMENTATION

BLK	BLACK POWER CORD
WH	WHITE POWER CORD
CLR	CLEAR POWER CORD

### FRAME FINISH FINI DU CADRE

BLKE	BLACK FINE TEXTURE
WHE	WHITE FINE TEXTURE

## MOUNTING OPTION OPTION DE MONTAGE

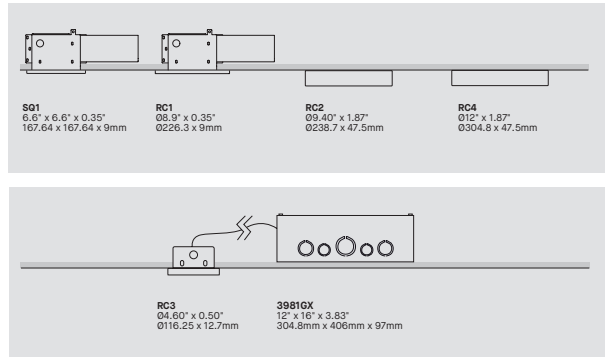

## ACCESSORY ACCESSOIRE

- 3981C** 1 JUNCTION BOX FOR 90W RECESSED DRIVER
- 3981D** 1 JUNCTION BOX FOR 180W RECESSED DRIVER
- 3981D2** 2 JUNCTION BOX FOR 360W RECESSED DRIVER
- 3981D4** 4 JUNCTION BOXES FROM 540W TO 740W RECESSED DRIVER
- 3981GA** 1 REMOTE DRIVER BOX 12"X16" FOR MOUNTING RC3 FOR DC LOAD 90W
- 3981GB** 1 REMOTE DRIVER BOX 12"X16" FOR MOUNTING RC3 FOR DC LOAD 180W
- 3981GB2** 2 REMOTE DRIVER BOXES 12"X16" FOR MOUNTING RC3 FOR DC LOAD 360W
- 3981GB3** 3 REMOTE DRIVER BOXES 12"X16" FOR MOUNTING RC3 FOR DC LOAD 540W
- 3981GB4** 4 REMOTE DRIVER BOXES 12"X16" FOR MOUNTING RC3 FOR DC LOAD 720W
- 39NLAA\*** NLIGHT AIR GEN 2 REMOTE CONTROLLER (NOT AVAILABLE WITH MOUNTING OPTION RC3)
- 39NLWA\*** NLIGHT WIRED REMOTE CONTROLLER (NOT AVAILABLE WITH MOUNTING OPTION RC3)

\* FOR CHICAGO PLENUM INSTALLATION, PLEASE CONTACT YOUR EUREKA REPRESENTATIVE

# ARENA SQUARE 8220

## CONFIGURATIONS

**8220-36X36**  
ARENA SQUARE 36" x 36"

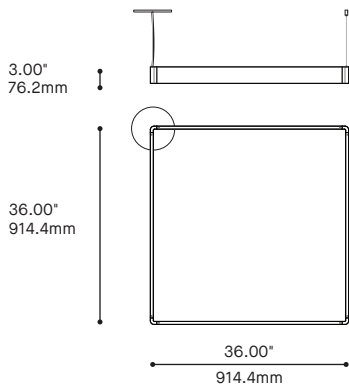

**8220-54X54**  
ARENA SQUARE 54" x 54"

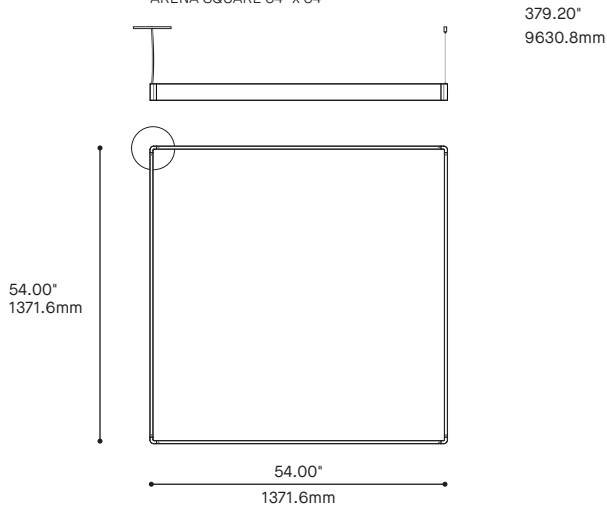

**8220-96X96**  
ARENA SQUARE 96" x 96"

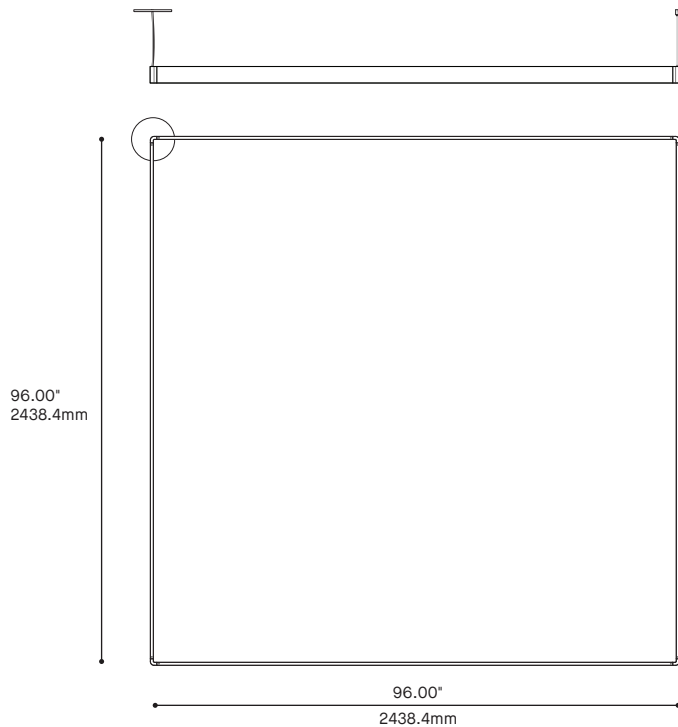

**8220-380X380**  
ARENA SQUARE 380" x 380"

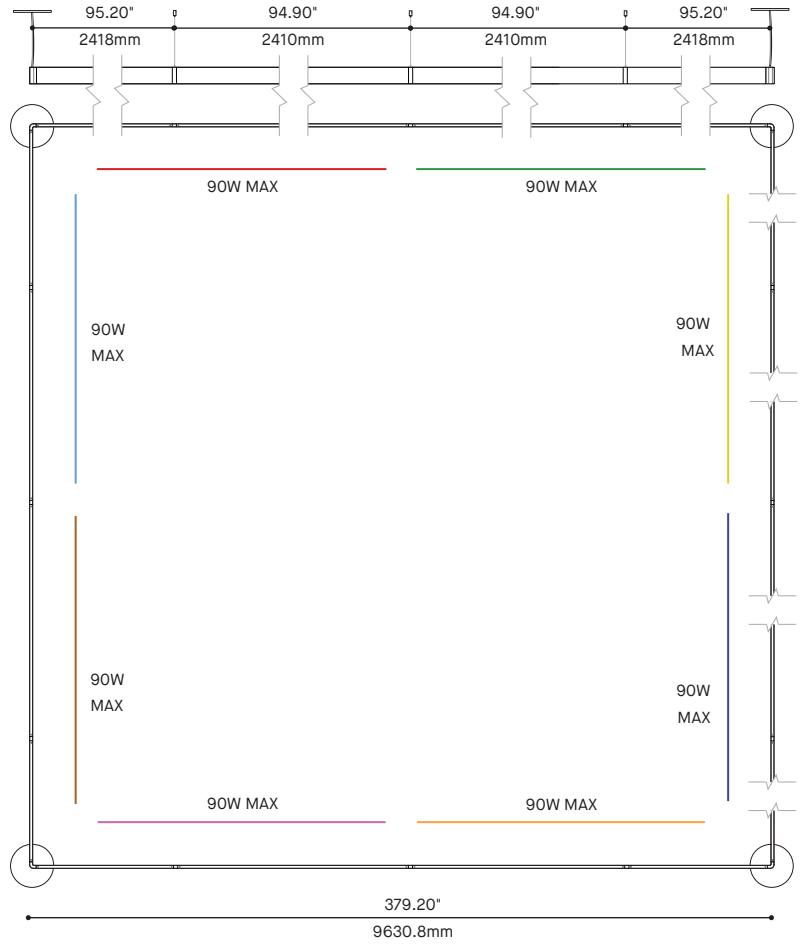

**8220-190X190**  
ARENA SQUARE 190" x 190"

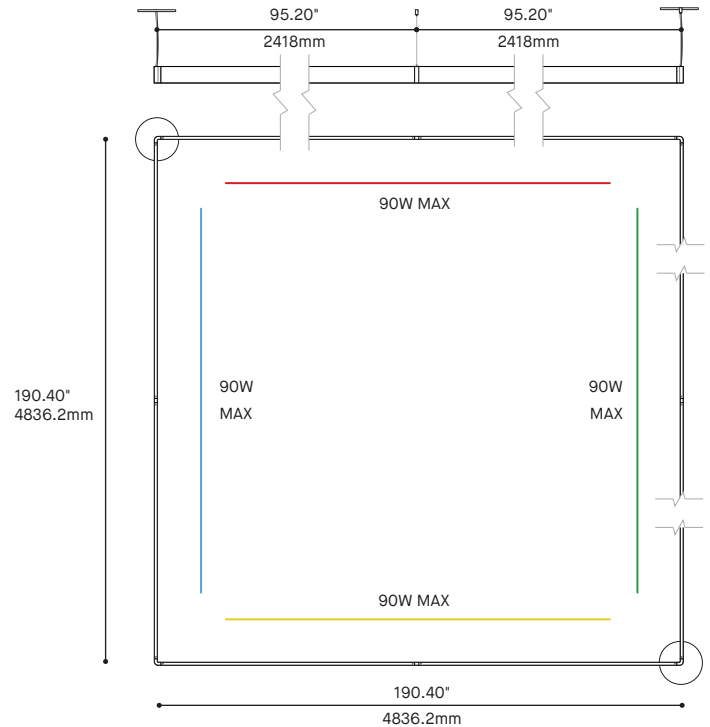

# ARENA RECTANGLE 8220 1/2

## CONFIGURATIONS

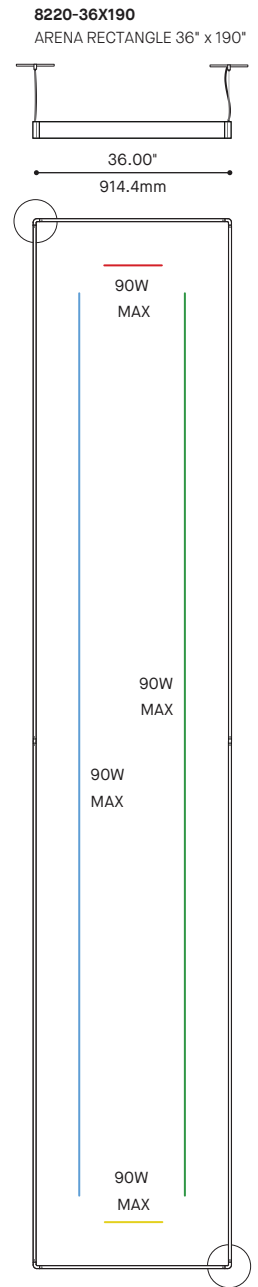
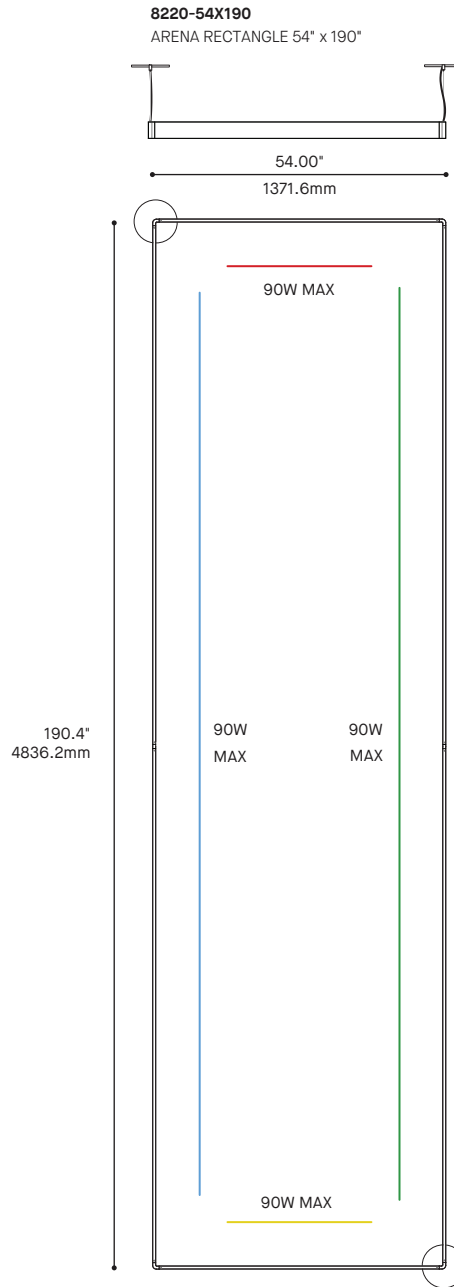
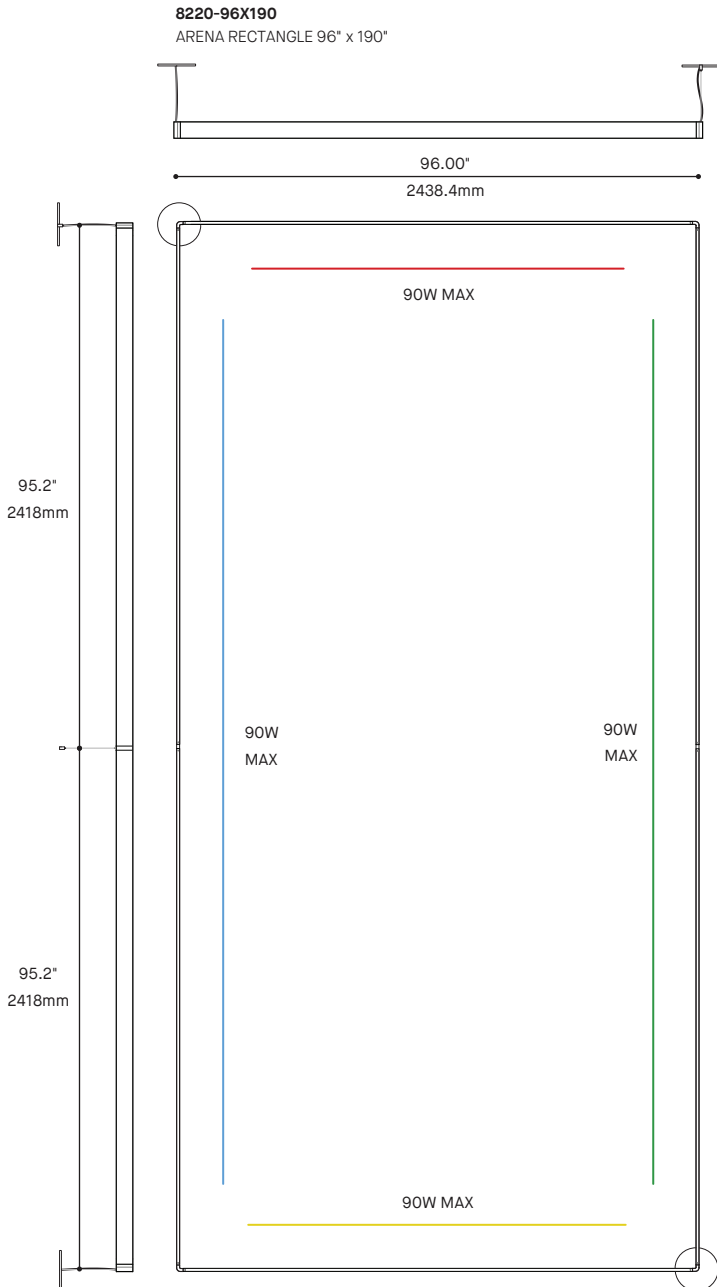
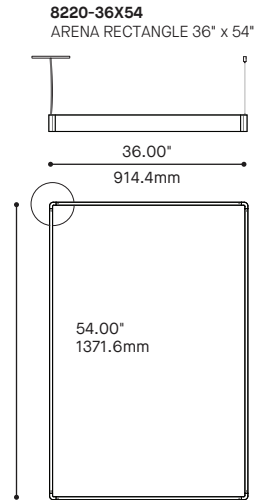
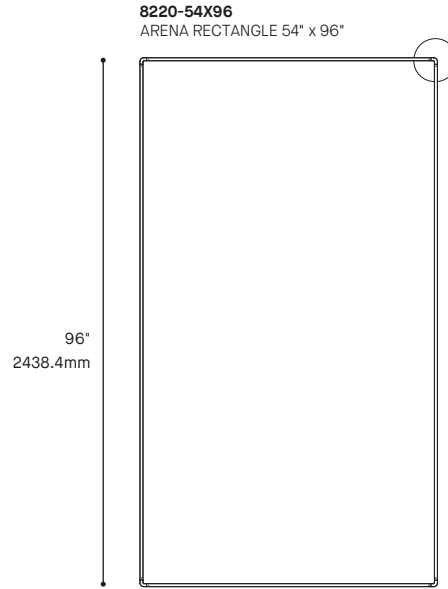
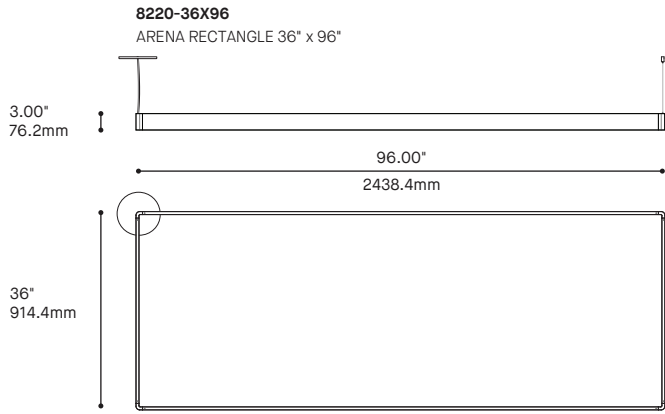

# ARENA RECTANGLE 8220 2/2

## CONFIGURATIONS

**8220-96X380**  
ARENA SQUARE 96" x 380"

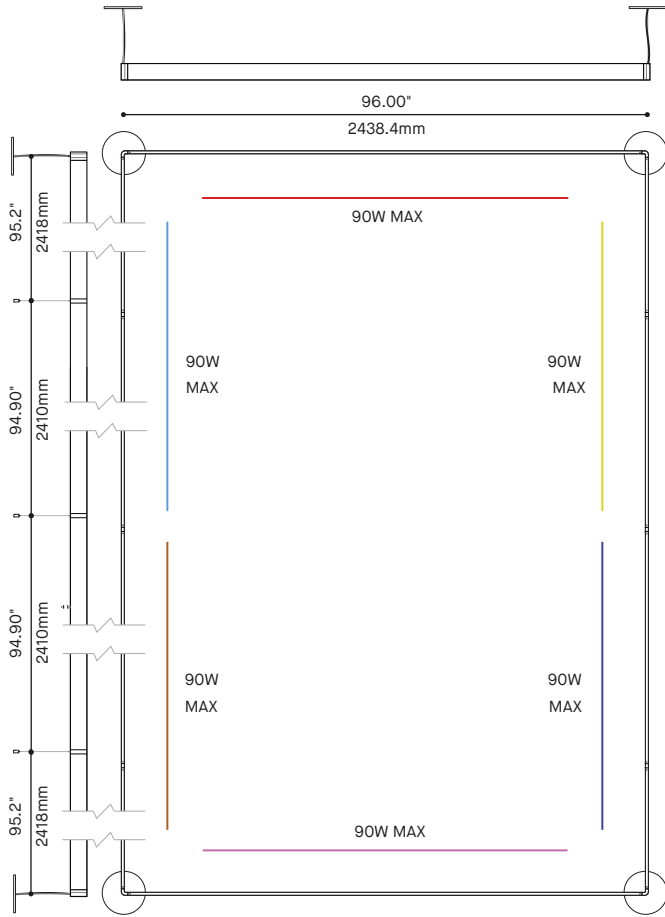

**8220-54X380**  
ARENA RECTANGLE 54" x 380"

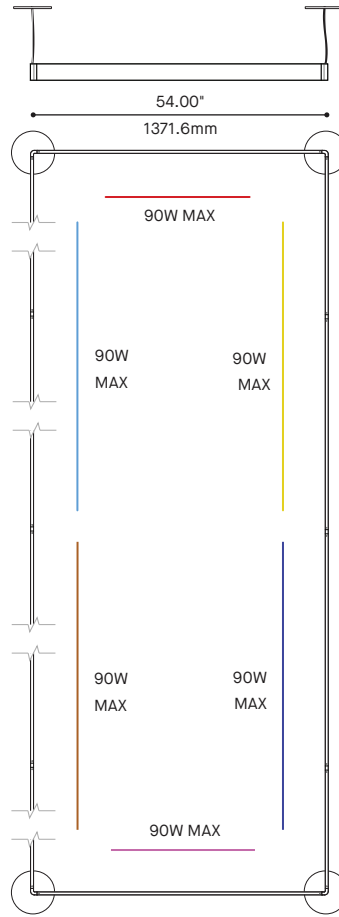

**8220-36X380**  
ARENA RECTANGLE 36" x 380"

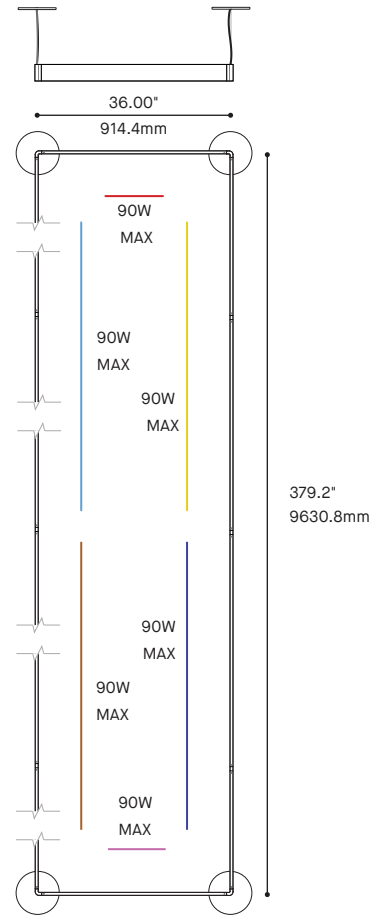

**8220-190X380**  
ARENA RECTANGLE 190" x 380"

