







Mika 4230-8

TECHNICAL DATA

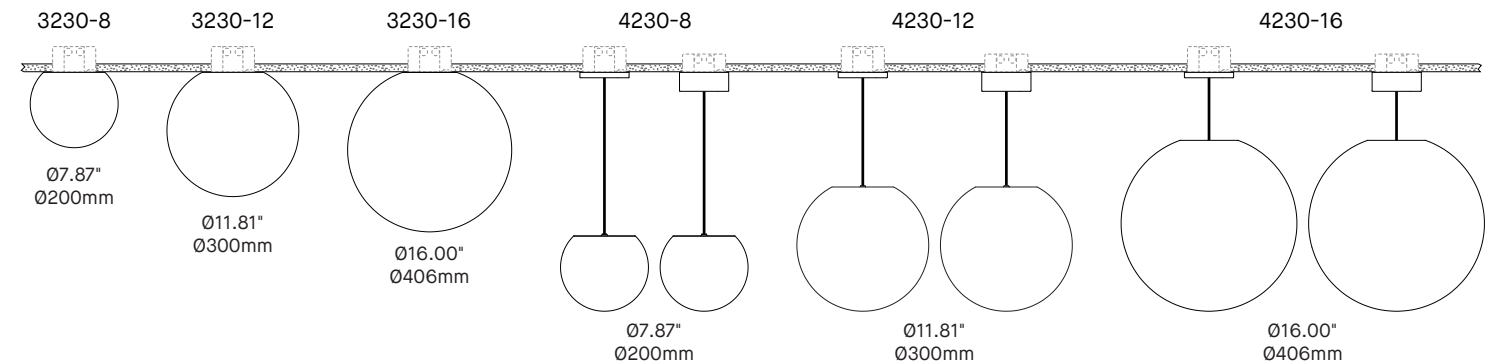
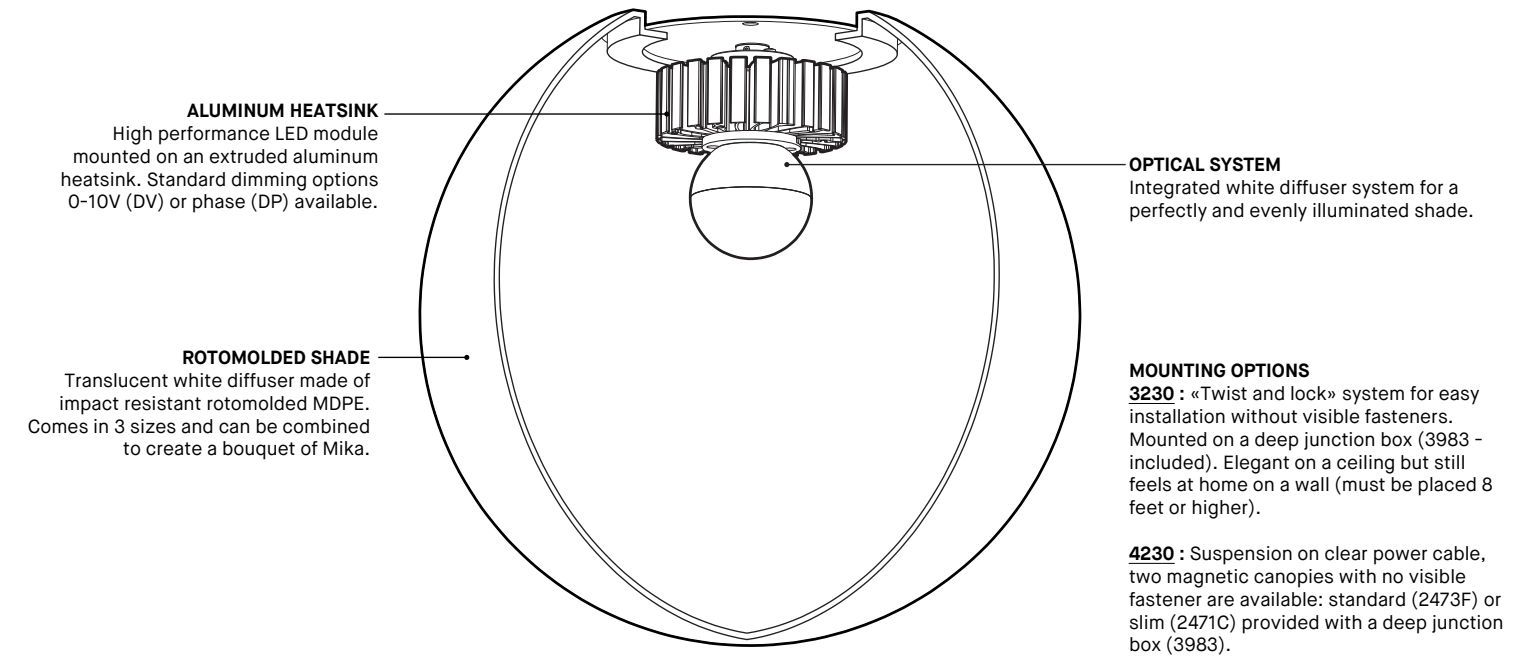

PRODUCT SPECIFICATION	3230-8	3230-12	3230-16	4230-8	4230-12	4230-16
PERFORMANCE						
SYSTEM WATTAGE	9.8 W	9.8 W	14.1 W	9.8 W	9.8 W	14.1 W
DELIVERED LUMENS (4000K)	987 LM	1062 LM	1523 LM	987 LM	1062 LM	1523 LM
EFFICACY	101 LM/W	108 LM/W	108 LM/W	101 LM/W	108 LM/W	108 LM/W
OTHER INFORMATIONS						
WEIGHT	2.2LBS / 1.0KG	2.3LBS / 1KG	3.5LBS / 1.6KG	2.2LBS / 1.0KG	2.3LBS / 1KG	3.5LBS / 1.6KG
L70 (LUMEN MAINTENANCE)	> 55 000 HRS	> 55 000 HRS	> 55 000 HRS	> 55 000 HRS	> 55 000 HRS	> 55 000 HRS
WELL & LEED STANDARD REQUIREMENTS						
MAX. LUMINANCE 45°-90° OF NADIR	2208 CD/M²	892 CD/M²	659 CD/M²	2208 CD/M²	892 CD/M²	659 CD/M²
LIGHT QUALITY	R9 > 50 (90 CRI OPTION)					
FLICKERING TOLERANCE	LOW FLICKER, COMPLIANT TO CALIFORNIA TITLE 24					

EFFICACY MULTIPLIERS

CRI	CCT	FACTOR
80+	4000K	1.00
80+	3500K	0.99
80+	3000K	0.97
80+	2700K	0.94
90+	4000K	0.89
90+	3500K	0.86
90+	3000K	0.84
90+	2700K	0.80

LIGHT DISTRIBUTION

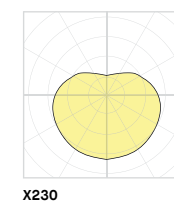

Visit our website for warranty terms and conditions.



MIKA 4230

PROJECT PROJET
SPEC TYPE
NOTES



OPTIONS



4230-8 4230-12 4230-16

FAMILY FAMILLE



4428-16-RAP 4428-10-RAP 3230-12

MOUNTING OPTIONS OPTIONS DE MONTAGE

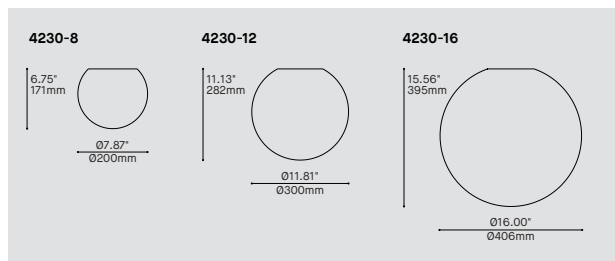
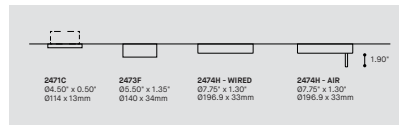

QUICKSHIP [CLICK HERE / CLIQUEZ ICI](#)

ORDERING SPECIFICATION SPÉCIFICATION DE COMMANDE

MODEL MODÈLE

4230-8	MIKA 8"
4230-12	MIKA 12"
4230-16	MIKA 16"

LIGHT SOURCE SOURCE LUMINEUSE

LED	REGULAR OUTPUT	LED
-----	----------------	-----

COLOR TEMPERATURE TEMPÉRATURE DE COULEUR (A)

27*	2700K
30	3000K
35	3500K
40	4000K

* LONGER LEAD TIME MAY APPLY. PLEASE CONTACT YOUR EUREKA REPRESENTATIVE

COLOR RENDERING INDEX (CRI) INDICE DE RENDU DE COULEUR (IRC)

80	80+ CRI
90*	90+ CRI

* LONGER LEAD TIME MAY APPLY. PLEASE CONTACT YOUR EUREKA REPRESENTATIVE

VOLTAGE VOLTAGE

120V	120 VOLT
277V	277 VOLT

CONTROL OPTION OPTION DE CONTRÔLE

DV	0-10V DIMMING (120V-277V)
DP	PHASE DIMMING (120V ONLY)
NLTAIR2*	NLIGHT AIR CONTROL GEN 2
NLIGHT*	NLIGHT WIRED CONTROL

* REQUIRES RC3 CANOPY. REFER TO NLIGHT GUIDE AND INSTALLATION SHEET FOR ALL REQUIREMENTS.
* EMERGENCY BATTERY NOT AVAILABLE WITH NLIGHT OPTIONS

EMERGENCY BATTERY BATTERIE D'URGENCE

EM DRIVER BOX INCLUDED , INSTALLED REMOTELY. SEE EM GUIDE FOR DETAILS.	
EMB (1)	EMERGENCY BATTERY FOR REMOTE BOX

(1) 3981E ACCESSORY IS REQUIRED FOR THIS OPTION

CABLE CÂBLE

C	CLEAR CABLE, FIELD ADJUSTABLE	C
---	-------------------------------	---

CABLE LENGTH LONGUEUR DE CÂBLE

60	60" CABLE (STD LENGTH)
**	CUSTOM CABLE LENGTH (PLEASE SPECIFY)

FOR OVERALL LENGTH, PLEASE CONTACT YOUR EUREKA REPRESENTATIVE

MOUNTING MONTAGE

RC1	ROUND CANOPY / PAVILLON ROND
RC2*	FOR DIMMING LED: 1.35" CANOPY (2473F)
RC3	FOR DIMMING LED: 0.5" CANOPY (2471C)
RC3	NLIGHT SCREWLESS CANOPY 07.75" x 1.30" (2474H)

* 3983 ACCESSORY PROVIDED

CANOPY FINISH FINI PAVILLON

WHE	WHITE FINE TEXTURE	WHE
-----	--------------------	-----

DIFFUSER FINISH FINI DIFFUSEUR

WH	WHITE	WH
----	-------	----

ACCESSORY ACCESSOIRE

3983*	DEEP JUNCTION BOX (PROVIDED FOR SCREWLESS 0.5" CANOPY 2471C)
-------	--

* JUNCTION BOX IS AVAILABLE FOR ADVANCE SHIPPING

EMERGENCY BATTERY ACCESSORY ACCESSOIRE BATTERIE D'URGENCE

3981EA	ELECTRICAL BOX FOR EMB EMERGENCY BATTERY
--------	--

PRODUCT CHARACTERISTICS CARACTÉRISTIQUES DU PRODUIT



DESIGN: Classic round globe with an evenly frosted shade available with 8", 12" and 16" diameters. Mika can be specified as a ceiling or wall mount and pendant.

INSTALLATION: Suspension on clear power cable, easy to install and adjust on site. Two magnetic canopies with no visible fastener are available: standard (2473F) or slim (2471C) provided with a deep junction box (3983).

LIGHT SOURCE: High performance LED module mounted on an extruded aluminum heatsink, Mika is offered with standard dimming options 0-10V (DV) or phase (DP). Emergency options available.

DIFFUSER: Translucent white diffuser made of impact resistant rotomolded MDPE.

CERTIFIED: c-CSA-us

MIKA 4230

QUICKSHIP [CLICK HERE / CLIQUEZ ICI](#)

PROJECT PROJET
SPEC TYPE
NOTES



OPTIONS



4230-8 4230-12 4230-16

FAMILY FAMILLE



4428-16-RAP 4428-10-RAP 3230-12

MOUNTING OPTIONS OPTIONS DE MONTAGE

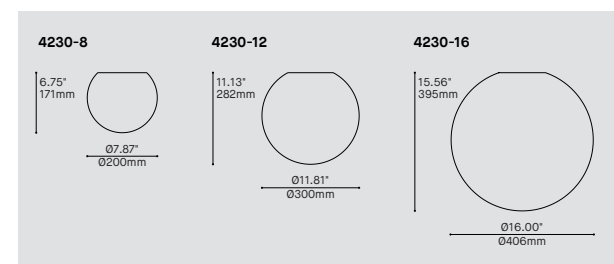
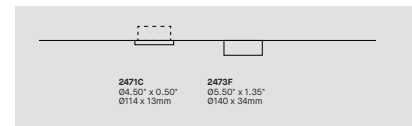

ORDERING SPECIFICATION SPÉCIFICATION DE COMMANDE

QUICKSHIP

QS5	QUICKSHIP 5 DAYS - MAXIMUM 5 UNITS	QUICKSHIP 5 JOURS - MAXIMUM 5 UNITÉS
QS10	QUICKSHIP 10 DAYS - MAXIMUM 20 UNITS	QUICKSHIP 10 JOURS - MAXIMUM 20 UNITÉS

MODEL MODÈLE

4230-8	MIKA 8"
4230-12	MIKA 12"
4230-16	MIKA 16"

LIGHT SOURCE SOURCE LUMINEUSE

LED	REGULAR OUTPUT	LED
-----	----------------	-----

COLOR TEMPERATURE TEMPÉRATURE DE COULEUR (A)

30	3000K
35	3500K
40	4000K

COLOR RENDERING INDEX (CRI) INDICE DE RENDU DE COULEUR (IRC)

80	80+ CRI	80
----	---------	----

VOLTAGE VOLTAGE

120V	120 VOLT
277V	277 VOLT

CONTROL OPTION OPTION DE CONTRÔLE

DV	0-10V DIMMING (120V-277V)
DP	PHASE DIMMING (120V ONLY)

CABLE CÂBLE

C	CLEAR CABLE, FIELD ADJUSTABLE	C
---	-------------------------------	---

CABLE LENGTH LONGUEUR DE CÂBLE

60	60" CABLE (STD LENGTH)
**	CUSTOM CABLE LENGTH (PLEASE SPECIFY)

FOR OVERALL LENGTH, PLEASE CONTACT YOUR EUREKA REPRESENTATIVE

MOUNTING MONTAGE

RC1	ROUND CANOPY / PAVILLON ROND
RC2*	FOR DIMMING LED: 1.35" CANOPY (2473F)
RC2*	FOR DIMMING LED: 0.5" CANOPY (2471C)

* 3983 ACCESSORY PROVIDED

CANOPY FINISH FINI PAVILLON

WHE	WHITE FINE TEXTURE	WHE
-----	--------------------	-----

DIFFUSER FINISH FINI DIFFUSEUR

WH	WHITE	WH
----	-------	----

ACCESSORY ACCESSOIRE

3983*	DEEP JUNCTION BOX (PROVIDED FOR SCREWLESS 0.5" CANOPY 2471C)
-------	--

* JUNCTION BOX IS AVAILABLE FOR ADVANCE SHIPPING

ADDITIONAL OPTIONS AVAILABLE ON STANDARD SHIPPING / OPTIONS ADDITIONNELLES DISPONIBLES EN LIVRAISON STANDARD

PRODUCT CHARACTERISTICS CARACTÉRISTIQUES DU PRODUIT



DESIGN: Classic round globe with an evenly frosted shade available with 8", 12" and 16" diameters. Mika can be specified as a ceiling or wall mount and pendant.

INSTALLATION: Suspension on clear power cable, easy to install and adjust on site. Two magnetic canopies with no visible fastener are available: standard (2473F) or slim (2471C) provided with a deep junction box (3983).

LIGHT SOURCE: High performance LED module mounted on an extruded aluminum heatsink, Mika is offered with standard dimming options 0-10V (DV) or phase (DP). Emergency options available.

DIFFUSER: Translucent white diffuser made of impact resistant rotomolded MDPE.

CERTIFIED: c-CSA-us

MIKA 3230

PROJECT PROJÉT
SPEC TYPE
NOTES



OPTIONS



3230-8

3230-12

3230-16

FAMILY FAMILLE



4428-16-RAP

4428-10-RAP

4230-12

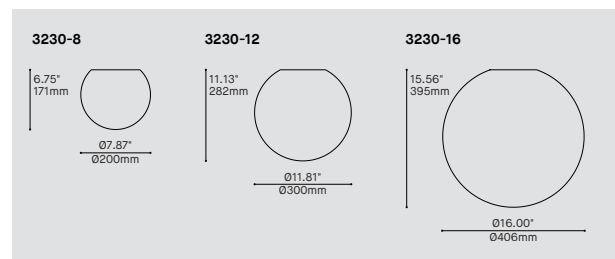

[QUICKSHIP](#) [CLICK HERE / CLIQUEZ ICI](#)

ORDERING SPECIFICATION SPÉCIFICATION DE COMMANDE

CODE

MODEL MODÈLE

3230-8	MIKA 8"
3230-12	MIKA 12"
3230-16	MIKA 16"

LIGHT SOURCE SOURCE LUMINEUSE

LED

LED REGULAR OUTPUT

COLOR TEMPERATURE TEMPÉRATURE DE COULEUR (A)

27*	2700K
30	3000K
35	3500K
40	4000K

*LONGER LEAD TIME MAY APPLY. PLEASE CONTACT YOUR EUREKA REPRESENTATIVE

COLOR RENDERING INDEX (CRI) INDICE DE RENDU DE COULEUR (IRC)

80	80+ CRI
90*	90+ CRI

*LONGER LEAD TIME MAY APPLY. PLEASE CONTACT YOUR EUREKA REPRESENTATIVE

VOLTAGE VOLTAGE

120V	120 VOLT
277V	277 VOLT

CONTROL OPTION OPTION DE CONTRÔLE

DV	0-10V DIMMING (120V-277V)
DP	PHASE DIMMING (120V ONLY)
NLTAIR2*	NLIGHT AIR CONTROL GEN 2
NLIGHT*	NLIGHT WIRED CONTROL *NLIGHT INTEGRATION REQUIRES A REMOTE POWER PACK (39NLAA FOR NLTAIR2 OR 39NLWA FOR NLIGHT). *EMERGENCY BATTERY NOT AVAILABLE WITH NLIGHT OPTIONS REFER TO NLIGHT GUIDE AND INSTALLATION SHEET FOR ALL REQUIREMENTS.

EMERGENCY BATTERY BATTERIE D'URGENCE

EM DRIVER BOX INCLUDED, INSTALLED REMOTELY. SEE EM GUIDE FOR DETAILS.

EMB ⁽¹⁾	EMERGENCY BATTERY FOR REMOTE BOX ⁽¹⁾ 3981E ACCESSORY IS REQUIRED FOR THIS OPTION
--------------------	--

DIFFUSER FINISH FINI DIFFUSEUR

WH

WH WHITE

ACCESSORY ACCESSOIRE

3983	DEEP JUNCTION BOX (PROVIDED)
39NLAA*	NLIGHT AIR GEN 2 REMOTE POWER PACK
39NLWA*	NLIGHT WIRED REMOTE POWER PACK *FOR CHICAGO PLENUM INSTALLATION, PLEASE CONTACT YOUR EUREKA REPRESENTATIVE.

EMERGENCY BATTERY ACCESSORY ACCESSOIRE BATTERIE D'URGENCE

3981EA	ELECTRICAL BOX FOR EMB EMERGENCY BATTERY
--------	--

PRODUCT CHARACTERISTICS CARACTÉRISTIQUES DU PRODUIT



DESIGN: Classic round globe with an evenly frosted shade available with 8", 12" and 16" diameters. Mika can be specified as a ceiling or wall mount and pendant. Designed with a "twist and lock" installation system for easy installation without visible fasteners. Mika is mounted on a deep junction box (3983 – included).

INSTALLATION: High performance LED module mounted on an extruded aluminum heatsink, Mika is offered with standard dimming options 0-10V (DV) or phase (DP). Emergency and nLight options available.

LIGHT SOURCE: Translucent white diffuser made of impact resistant rotomolded MDPE.

DIFFUSER: c-CSA-us

CERTIFIED: c-CSA-us

MIKA 3230

[QUICKSHIP](#)

PROJECT PROJÉT
SPEC TYPE
NOTES



OPTIONS



3230-8

3230-12

3230-16

FAMILY FAMILLE



4428-16-RAP

4428-10-RAP

4230-12

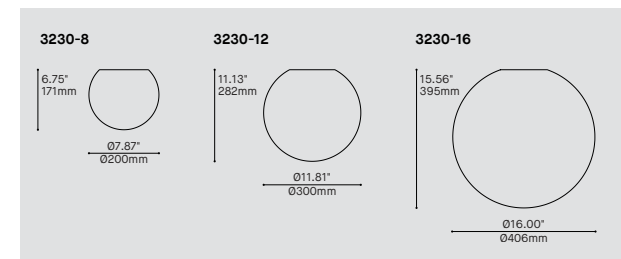

ORDERING SPECIFICATION SPÉCIFICATION DE COMMANDE

CODE

QUICKSHIP

QS5	QUICKSHIP 5 DAYS - MAXIMUM 5 UNITS	QUICKSHIP 5 JOURS - MAXIMUM 5 UNITÉS
QS10	QUICKSHIP 10 DAYS - MAXIMUM 20 UNITS	QUICKSHIP 10 JOURS - MAXIMUM 20 UNITÉS

MODEL MODÈLE

3230-8	MIKA 8"
3230-12	MIKA 12"
3230-16	MIKA 16"

LIGHT SOURCE SOURCE LUMINEUSE

LED

LED REGULAR OUTPUT

COLOR TEMPERATURE TEMPÉRATURE DE COULEUR (A)

30	3000K
35	3500K
40	4000K

COLOR RENDERING INDEX (CRI) INDICE DE RENDU DE COULEUR (IRC)

80	80+ CRI
----	---------

80

VOLTAGE VOLTAGE

120V	120 VOLT
277V	277 VOLT

CONTROL OPTION OPTION DE CONTRÔLE

DV	0-10V DIMMING (120V-277V)
DP	PHASE DIMMING (120V ONLY)

DIFFUSER FINISH FINI DIFFUSEUR

WH

WH WHITE

ACCESSORY ACCESSOIRE

3983*	DEEP JUNCTION BOX (PROVIDED DV AND DP) * JUNCTION BOX IS AVAILABLE FOR ADVANCE SHIPPING
-------	--

ADDITIONAL OPTIONS AVAILABLE ON STANDARD SHIPPING / OPTIONS ADDITIONNELLES DISPONIBLES EN LIVRAISON STANDARD

PRODUCT CHARACTERISTICS CARACTÉRISTIQUES DU PRODUIT



DESIGN: Classic round globe with an evenly frosted shade available with 8", 12" and 16" diameters. Mika can be specified as a ceiling or wall mount and pendant.

INSTALLATION: Designed with a "twist and lock" installation system for easy installation without visible fasteners. Mika is mounted on a deep junction box (3983 – included).

LIGHT SOURCE: High performance LED module mounted on an extruded aluminum heatsink, Mika is offered with standard dimming options 0-10V (DV) or phase (DP). Emergency and nLight options available.

DIFFUSER: Translucent white diffuser made of impact resistant rotomolded MDPE.

CERTIFIED: c-CSA-us



PHOTO CREDIT : Patricia Brochu
Mika Bouquet 4428-16-RAQ-13

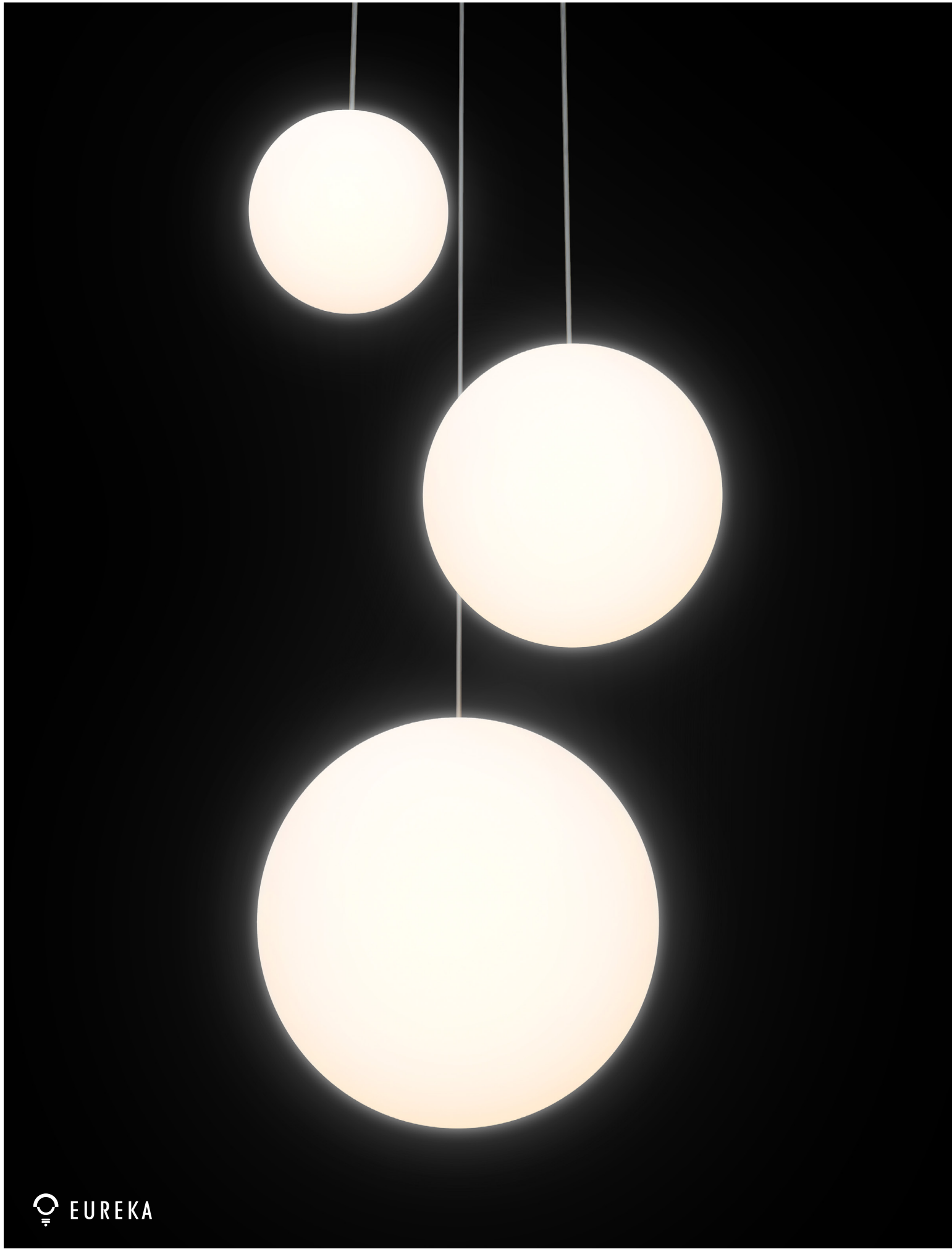

MIKA 3230 - 4230

X230-8-LED.40

CCT (K):	4000
Delivered Lumens (lm):	987
System wattage (W)*:	9.8
Distribution:	Direct/Indirect
Delivered Efficacy (lm/W):	101
Photometric type	C

Luminous dimensions

Luminous shape:	Rectangle
Units:	in (mm)
0-180 Axis:	7.9 (200)
90-270 Axis:	7.9 (200)
Height:	7.9 (200)

Luminaire spacing criteria

2 luminaires, plane 0:	1.53
2 luminaires, plane 90:	1.55
4 luminaires:	1.72

*System wattage include driver and LED module consumption

X230-12-LED.40

CCT (K):	4000
Delivered Lumens (lm):	1062
System wattage (W)*:	9.8
Distribution:	Direct/Indirect
Delivered Efficacy (lm/W):	108
Photometric type	C

Luminous dimensions

Luminous shape:	Rectangle
Units:	in (mm)
0-180 Axis:	11.8 (300)
90-270 Axis:	11.8 (300)
Height:	11.8 (300)

Luminaire spacing criteria

2 luminaires, plane 0:	1.51
2 luminaires, plane 90:	1.51
4 luminaires:	1.70

*System wattage include driver and LED module consumption

X230-16-LED.40

CCT (K):	4000
Delivered Lumens (lm):	1523
System wattage (W)*:	14.1
Distribution:	Direct/Indirect
Delivered Efficacy (lm/W):	108
Photometric type	C

Luminous dimensions

Luminous shape:	Rectangle
Units:	in (mm)
0-180 Axis:	15.7 (400)
90-270 Axis:	15.7 (400)
Height:	15.7 (400)

Luminaire spacing criteria

2 luminaires, plane 0:	1.58
2 luminaires, plane 90:	1.58
4 luminaires:	1.76

*System wattage include driver and LED module consumption

